

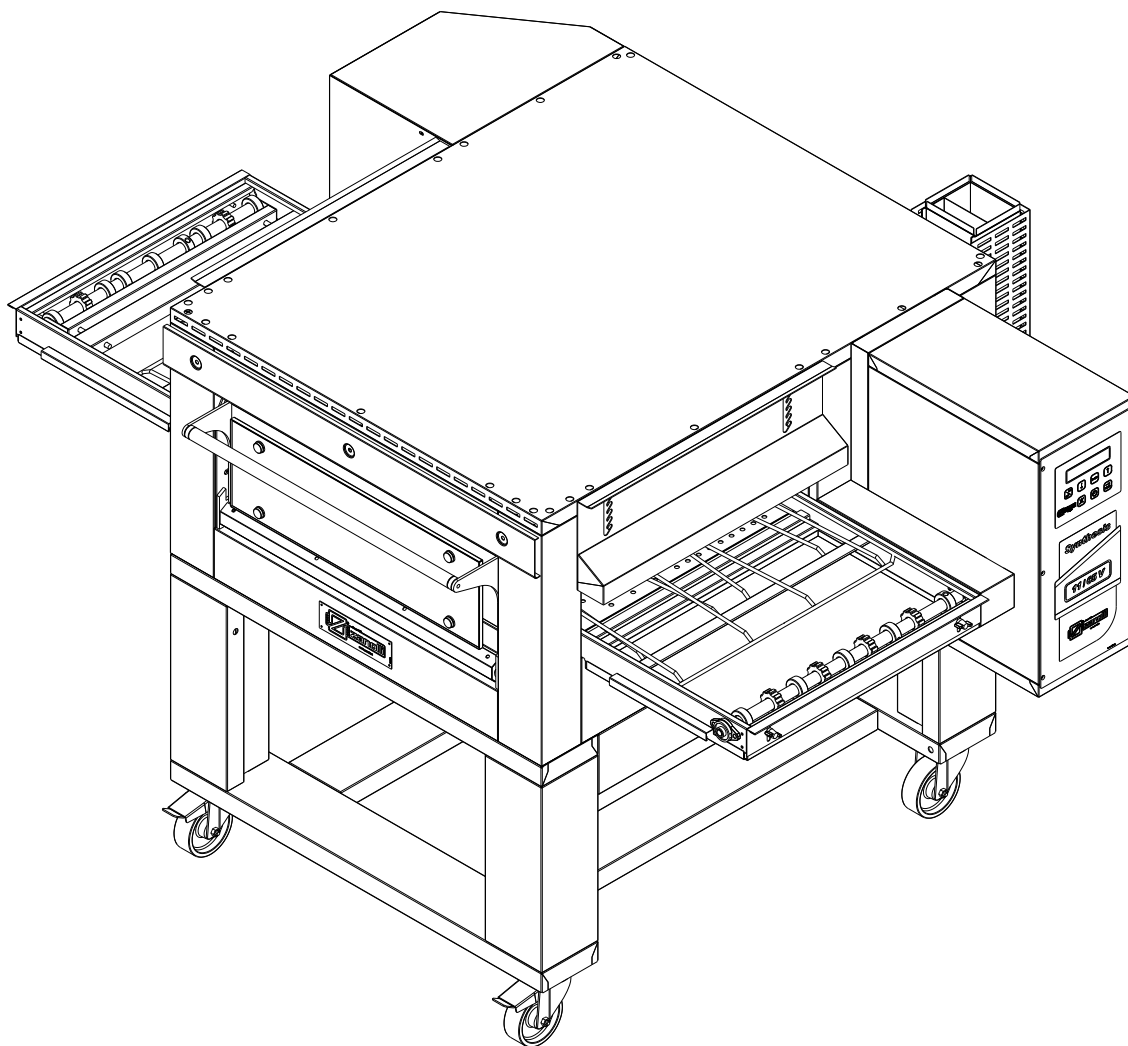

Forni e Macchine • Ovens and Machines

DR. ZANOLLI s.r.l.  
Via Casa Quindici, 22  
37066 Caselle di Sommacampagna  
(Verona) Italy  
Tel +39 045 8581500 (r.a.)  
Fax +39 045 8581455  
Web: [www.zanolli.it](http://www.zanolli.it) • e-mail: [zanolli@zanolli.it](mailto:zanolli@zanolli.it)



# SYNTHESIS

## 08/50 V PW GAS

Manuale di installazione, uso e manutenzione  
Manual for installation, use and maintenance  
*Manual de instalación, uso y mantención*  
*Notice d'installation, d'utilisation et d'entretien*  
INSTALLATIONS-, BEDIENUNGS- UND INSTANDHALTUNGSHANDBUCH

cod. SY0850PW.G.D.11 - rev. 0.3 del 01/09/2015



**DICHIARAZIONE DI CONFORMITÀ  
DECLARATION OF CONFORMITY  
DECLARACIÓN DE CONFORMIDAD  
DÉCLARATION DE CONFORMITÉ  
KONFORMITÄTSEKTLÄRUNG**



Noi  
*We / El que suscribe /  
Nous / Wir*

**Dr. ZANOLLI s.r.l.**  
**Via Casa Quindici, 22**  
**37066 Caselle di Sommacampagna, VR**

dichiaro sotto la nostra esclusiva responsabilità che l'apparecchiatura  
*declare under our responsibility that the equipment / declara bajo su propia responsabilidad que l'equipo /  
déclarons sous notre responsabilité que l'appareil / erklären in alleiniger Verantwortung, daß das Gerät*

**Marca**

*Manufactured by / Marca / Marque de fabrique / Bezeichnung*

**Modello**

*Model / Modelo / Model / Modell*

**N° di serie**

*Serial number / N° de serie / N° de série / Seriennummer*

**Anno di costruzione**

*Year of construction / Año de construcción / Année de construction / Baujahr*

come descritto nella documentazione allegata, è in conformità con le seguenti direttive europee  
*is in conformity with the following European Directives / es conforme con las siguientes Directivas europeas /  
est conforme aux suivantes Directives européennes / auf das sich diese Erklärung bezieht, mit den E - Normen*

**- 2014/35/CE Direttiva Bassa Tensione**

*Low Tension Directive / Directiva Baja Tension / Directive Basse Tension / Niederspannungsrichtlinie*

**- 2014/30/CE Direttiva Compatibilità Elettromagnetica**

*Electromagnetic Compatibility Directive / Directiva Compatibilidad Electromagnetica /  
Directive Compatibilité Electromagnétique / Elektromagnetische Verträglichkeit*

**- 2006/42/CE Direttiva Macchine**

*Machines Directive / Directiva Maquinas / Directive Machines / Maschinenrichtlinie*

**- 2009/142/CE Direttiva Gas**

*Gas Directive / Directiva Gas / Directive Gaz / Gasrichtlinie*

**- 1935/2004/CE Regolamento Oggetti destinati a venire in Contatto con i Prodotti Alimentari**

*Regulation for Equipment intended to come into Contact with Foodstuffs / Normativa para Equipos destinados a  
entrar en Contacto con Alimentos / Réglementation Objets destinés à venir en Contact avec des Produits  
Alimentaires / Gesetzliche Regelung der Gegenstände, die mit Lebensmitteln in Kontakt kommen*

**e con le norme cogenti alle direttive.**

*and with the compulsory regulations of the Directives / y con las normas ineludibles de las Directivas /  
et aux normes inéluctables des Directives / und mit den Zwangsvorschriften der Richtlinien, übereinstimmt*

Caselle di Sommacampagna

**Dr. Zanolli s.r.l.**

**Collaudatore**

*Tester / Ensayador / Testateur / Prüfer*

ALL 7.2-C4 Dichiarazione di Conformità

Rev.4 del 7/07/2014

**Dr. ZANOLLI s.r.l.**

Via Casa Quindici, 22  
37066 Caselle di Sommacampagna (Verona) Italy  
Tel. + 39 045 8581500 (r.a.)  
Fax + 39 045 8581455  
web: [www.zanolli.it](http://www.zanolli.it) • e-mail: [zanolli@zanolli.it](mailto:zanolli@zanolli.it)

Capitale sociale € 93.600,00  
Reg. Imprese N. 3367  
Cod. Fisc./Part. IVA 00213620230  
Codice Comunitario IT 00213620230  
R.E.A. VERONA N. 57706  
Export M. VR005011

## INDEX

<b>1. INTRODUCTION .....</b>	<b>5</b>
<b>2. HOW TO USE THIS MANUAL.....</b>	<b>6</b>
<b>3. TECHNICAL SPECIFICATIONS.....</b>	<b>8</b>
<b>3.1. Identifying the product .....</b>	<b>8</b>
<b>3.2. Directives compliance .....</b>	<b>8</b>
<b>3.3. Foreseen range of use.....</b>	<b>8</b>
<b>3.4. Technical Specifications .....</b>	<b>8</b>
<b>4. INSTALLATION.....</b>	<b>9</b>
<b>4.1. Checking on delivery .....</b>	<b>9</b>
<b>4.2. Choosing a place for installation.....</b>	<b>9</b>
4.2.1. Location specifications for the installation of gas ovens.....	10
<b>4.3. Moving the unit .....</b>	<b>11</b>
<b>4.4. Positionig the unit on its base .....</b>	<b>11</b>
<b>4.5. Positioning stacked units.....</b>	<b>11</b>
<b>4.6. Electrical connection.....</b>	<b>12</b>
<b>4.7. Connecting the gas.....</b>	<b>13</b>
<b>4.8. Exhaust produced by combustion.....</b>	<b>13</b>
<b>4.9. Checking before starting work .....</b>	<b>15</b>
<b>5. OPERATION.....</b>	<b>16</b>
<b>5.1. Control panel.....</b>	<b>16</b>
<b>5.2. Functional states of the system.....</b>	<b>17</b>
5.2.1. Inactive state .....	17
5.2.2. State of activity .....	17
<b>5.3. Settings .....</b>	<b>18</b>
5.3.1. Setting the current time.....	18
5.3.2. Setting the language.....	18
<b>5.4. Programming .....</b>	<b>19</b>
5.4.1. Cooking programs .....	19
5.4.2. Cooking time adjustment .....	20
5.4.3. Temperature adjustment.....	20
5.4.4. Economy Fuction .....	21
5.4.5. Programming switching on.....	22
<b>5.5. Switching off the oven.....</b>	<b>23</b>
<b>5.6. Alarms.....</b>	<b>23</b>
5.6.1. "OVER 1" .....	23
5.6.2. "OVER 2" .....	23
5.6.3. "OVER" .....	24
5.6.4. "BELT" .....	24
5.6.5. "FAN" .....	24
5.6.6. "PRESS" .....	24
5.6.7. "FLAME" .....	25
5.6.8. "BATTERY" .....	25

<b>6. USE</b> .....	<b>26</b>
<b>6.1. Preparation for use and before turning</b> .....	<b>26</b>
6.1.1. Ignition Control Panel .....	26
6.1.2. Settings and start cooking .....	26
6.1.3. How to turn off the oven .....	27
<b>7. SAFETY WARNINGS</b> .....	<b>28</b>
<b>7.1. Prohibited actions and obligations towards the prevention of accidents</b> .....	<b>28</b>
7.1.1. Warnings for installers.....	28
7.1.2. Warnings for users .....	28
7.1.3. Warnings for the maintenance operator .....	29
<b>8. CLEANING</b> .....	<b>30</b>
<b>8.1. Cleaning removable parts</b> .....	<b>30</b>
<b>8.2. Cleaning of external parts</b> .....	<b>31</b>
<b>8.3. Cleaning the baking chambers</b> .....	<b>31</b>
<b>9. MAINTENANCE</b> .....	<b>32</b>
<b>9.1. Error indicator</b> .....	<b>32</b>
<b>9.2. Safety thermostat</b> .....	<b>32</b>
<b>9.3. Replace battery</b> .....	<b>33</b>
<b>9.4. Adjustment to different gas type</b> .....	<b>34</b>
9.4.1. Replacement of burner injector .....	34
9.4.2. Adjustment of minimum power .....	35
9.4.3. Application of new label.....	35
<b>10. DECOMMISSIONING AND DEMOLITION</b> .....	<b>36</b>

## **TECHNICAL ENCLOSURES**

- A. Technical Specifications
- B. Connections
- C. Wiring diagrams
- D. Exploded views

## 1. INTRODUCTION

The gas conveyor ovens mod. **SYNTHESIS gas** have been designed mainly for the automatic cooking of pizza and similar products. They are conveyor ovens. Favourable peculiarity of these particular ovens is that it is possible to make excellent baking, without controlling the same. For this reason it is possible for an unqualified staff to use the oven.

**SYNTHESIS** belong to the family of conveyor ovens. Another important innovation is that **SYNTHESIS**, thanks to their ventilation system, enable an excellent and uniform baking. In fact, the flow of hot air surrounds the product, removing the barrier of colder air that normally insulates it. This ensures an uniform distribution of the heat in appropriate dosage, in order to prevent the product from drying out excessively and giving it proper fragrance.

Finally, **SYNTHESIS gas**, are useful for those user located in areas where high electrical powers are not available. These conveyor ovens allow also a reduction of operation cost.

Thank you for the preference given to us. We can confidently assure you about your good choice, as our company has been committed to the production of quality items since decades, without useless restriction in the choice of the best materials.

To get the best use out of your new oven please read the information contained in this manual carefully.

## 2. HOW TO USE THIS MANUAL

 The paragraphs marked with this symbol contain indications essential to safety. They must all be read by installers, the end user and any employees that use the machine. Manufacturer does not assume any responsibility for damage or injury incurring as a result of ignoring the safety criteria outlined in these paragraphs.

 This symbol applied to various surfaces of the machine, shows that these can reach very high temperatures and should never be touched without taking the necessary precautions.

 This symbol, applied to various points on the machine, serves to warn the user of the presence of a non-insulated “high voltage hazard” inside the machine’s casing there being enough power to constitute a fire risk or to electrocute a person.

 The paragraphs marked with this symbol contain important information to avoid causing damage to the machine. It is in the users own interests to read these paragraphs carefully.

 It is recommended that this installation, instruction and service manual be kept in close proximity to the equipment so that it can be easily and quickly consulted. The manual must accompany the equipment if it is resold as it cannot be considered complete and safe without it.

Take note of the manual code and version shown on the back cover. In the event that this copy is lost or destroyed, you can order another using these

 This manual is made up of a number of chapters. They should be read in their entirety by both installers and service personnel as well as by the end user to ensure **safety of use** and to get the best results from this product.

Some useful indications for the consultation of each chapter are given below.

**Chapter 3** contains the reference standards of the oven and directions for the proper use of the same.

**Chapter 4** contains all the information needed to install the machine. These are mainly aimed at specialized personnel but should be read by the end user beforehand so as to predispose the environment where the machine will be operated for the installation.

**Chapters 5, 6 and 7 are intended for the user who has to learn how to use the machine.** These serve as a guide to the essential operations of turning on, using and turning off of the machine under safe conditions.

**Chapter 8** gives all the information necessary for the cleaning of the equipment: all those operations that must be carried out by the user to guarantee that it continues to function under safe, hygienic and sanitary conditions and continues to give the best results.

**Chapter 9** gives all information necessary for periodic or extraordinary maintenance, e.g. repairing or replacing parts of the equipment.

**⚠ These maintenance operations must be carried out by specialized personnel.**

**Chapter 10** gives directions for dismantling the machine.

**The technical annexes** contain features related to the specific model of oven and all values which may be necessary for the selection, installation and use. This chapter should be used as a point of reference to check that the way the owner intends to use it is in line with the way the machine has been designed to operate and ensure that and ensure that information concerning the precise value of a given measurement or tolerance of the equipment is available whenever necessary.

This chapter also provides a description of the electrical equipment that comes with the machine, the exploded of equipment and a list of spare parts, to facilitate order and replace any damaged parts.

**⚠** The Manufacturer reserves the right to update the production series and instruction manuals without the obligation to update the previous production series and previously issued instruction manuals.

## 3. TECHNICAL SPECIFICATIONS

### 3.1. Identifying the product

This manual refers to conveyor oven **SYNTHESIS** gas.

### 3.2. Directives compliance

The oven **SYNTHESIS** carry the **CE** obligatory mark, that guaranteeing their conforming to the following European directives:

2014/35/CE low current directive;

2014/30/CE electromagnetic compatibility directive;

2006/42/CE machines directive;

2009/142/CE Gas Directive

1935/2004/CE Regulation objects destined for coming into contact with food products.

### 3.3. Foreseen range of use

The gas conveyor oven mod. Synthesis is designed to cook pizza, or similar products. It is intended for professional use in the catering industry (restaurant, pizza shop, etc..).

The normal operations are the loading and unloading of products on the conveyor, the switching on, adjusting, switching off and cleaning of the appliance.

 The use to which the product should be put as stated above and the configurations foreseen for this equipment are the only ones authorized by the Manufacturer. **Do not use these machines in any way other than that indicated in the instructions provided.**

 The use intended is only valid for equipment which is in good structural, mechanical and electrical condition.

### 3.4. Technical Specifications

For technical specifications refer to the following technical annexes at the end of this manual:

A. Technical Specifications

B. Connections

C. Wiring diagrams

D. Exploded views



## 4. INSTALLATION

 **ATTENTION!** These installation instructions are for the exclusive use of personnel qualified for the installation and maintenance of electrical or gas equipment conceived for professional use in the foodservice industry and community catering operations. An installation carried out by unqualified persons could cause damage to the machine, to people, animals or property

 **ATTENTION!** Proceed with the installation according to those norms in force in the country where it is being carried out.

In addition, where it is necessary to carry out modifications or adaptations to the electrical systems of the building in which the machine will be installed, whoever carries out such modifications must certify that the work has been undertaken according to current “best practices”.

### 4.1. Checking on delivery

Unless otherwise agreed, the products are carefully packaged in a robust structure in wood and with a sheet of nylon bubble wrap giving protection against knocks and humidity during transport. These are consigned to the freight operator in the best of condition.

We recommend, however, that you to check the packaging on arrival for any signs of damage. If damage has occurred, have it noted on the receipt which must be signed by the driver.

Once the equipment has been unpacked, check that it has not suffered damage. Also check that all the disassembled parts are present.

In the event of damage to the equipment and/or missing parts, bear in mind that the freight operator can only accept claims within 15 days of delivery and that the manufacturer cannot be held responsible for damage incurred to its products during their delivery. We are however, available to assist you in presenting your claim.

 **In the event of damage do not try to use the equipment and consult with professionally qualified personnel.**

### 4.2. Choosing a place for installation

An effective, safe and long lasting functioning of the appliance also depends on the position in which it is installed. For this reason, it is advisable to carefully consider where to install the equipment before it is delivered.

Install the appliance in a dry and easily accessible place both to facilitate its use and to carry out cleaning and maintenance.

**⚠ The appliance must be installed at least 20cm from the walls of the room or from other equipment so that the ventilation outlets located on the sides of the oven are not obstructed.**

Whilst in operation, cooking equipment produces vapor and cooking smells that compromise the integrity of a healthy working environment.

In the case of gas ovens see paragraph 4.8.

**⚠** A check must be made to ensure that the temperature and relative humidity never exceed the maximum and minimum values indicated in the specifications (see Enclosure A) even when the machine or other machines in the room are functioning.

Exceeding these values especially the temperature or the maximum relative humidity can easily and unexpectedly damage electrical equipment creating hazardous situations.

### **4.2.1. Location specifications for the installation of gas ovens**

**⚠ It is the installer's responsibility to check that the gas system of the room in which the oven will be installed is working properly and that the ventilation and aeration conduits of this room function as required for the total nominal heat input.**

**⚠ The Manufacturer cannot answer for damage caused by failure to observe the norms in force for the installation of gas equipment.**

During the installation, care must be taken to avoid obstructing the cooling vents and the air intakes for combustion air built into the oven.

When dealing with gas equipment, the room in which it will be installed must be sufficiently ventilated and aerated. To ensure this, the enclosed area in which it will be housed must have at least two permanent apertures leading directly through its walls leading to the open air.

As an indication, for every kW of power installed, an air renewal rate of 36 m<sup>3</sup>/h is recommended.

To get a clear idea of the specifications required for the housing location, refer to the norms in force in the country where the installation is being carried out, in particular those prescribed for this type of oven.

### 4.3. Moving the unit

To offload and transport the unit, use a pallet truck or a transpallet lifter with a load capacity at least equal to that of the unit. Raise the doors at the entrance and exit of the oven to the position of maximum aperture. Insert the forks into the cooking chamber by way of the tunnel entrance or exit (Fig.1).

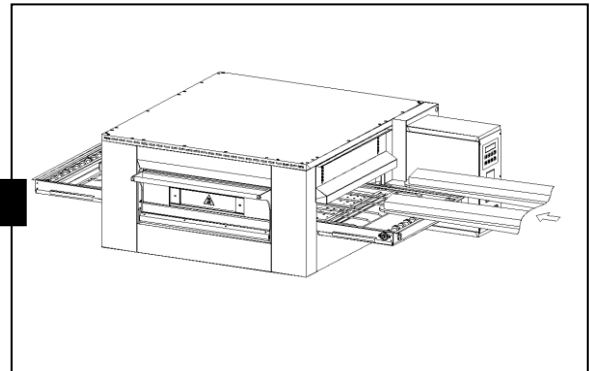

⊘ To avoid damage, place protective material between the forks and the unit.

⚠ Make sure that the lifting equipment has a lifting capacity superior to that of the weight of the load.

All responsibility for the lifting of loads rests with the person doing the lifting.

⚠ In all circumstances, to avoid unpredictable movement, be aware of the equipment's centre of mass.

⚠ Take care that children do not play with the packaging materials (e.g., plastic sheeting and Styrofoam): suffocation danger!

### 4.4. Positioning the unit on its base

Position the oven by sliding it into the four corners of the basement (Fig.2).

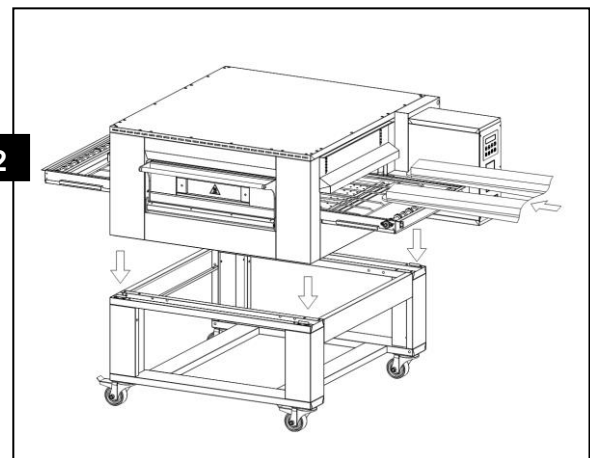



### 4.5. Positioning stacked units

⚠ FOR THE UNITS THAT CAN BE STACKED ONE ON TOP OF THE OTHER SEE ENCLOSURE B.

Once the first oven has been positioned on the base (see previous paragraph), overlap consecutively the second and third module fit the chimney exhaust fumes and by matching the exterior side walls of the ovens.

## 4.6. Electrical connection

 Before making any connection, check that the specifications of the electrical supply to which the equipment must be connected, correspond to the specifications of the power supply required by the apparatus itself (see Enclosure A).

 The appliances are supplied with an electric connection with ground/earth cable for connecting the appliance to the power grid according to the supply required (see Enclosure A).

In compliance with the safety norms in force. **It is obligatory to connect the ground/earth cable (yellow-green) to an earthing system with the same dispersion capacity as the appliance itself. The efficiency of this system must be correctly verified according to the norms in force.**

The power cable must terminate with a plug to connect to the electrical switchgear having a corresponding differential magneto thermal switch.

 **The equipment is not supplied with a power plug.**

The coupling between plug and socket must be such that the earth conductor is connected first and disconnected last and must have the right dimensions for the rated current (see Enclosure A). Plugs and sockets for industrial use of the type CEE17 are suitable or those which satisfy European norm EN 60309.

The thermal circuit breaker must be calibrated to the total rated current and the magnetic circuit breaker calibrated to the rated current (In the case of ovens this is only slightly higher than rated current), while the differential mechanism must be calibrated to the 30 mA current (see Enclosure A).

The electrical socket must be easily accessible and must not require further location after the installation of the equipment. The distance between the equipment and the socket must be sufficient to avoid stretching the power cable.

For the position of the electrical power connections Enclosure B.

 **The power cable must never be trapped under the feet or wheels of the equipment.**

 **If the power cable is damaged it must be substituted by customer support or by a qualified service engineer so as to avoid any risk.**

**The Manufacturer does not accept responsibility for damage caused by failure to observe the abovementioned norms.**

#### **4.7. Connecting the gas**

 Before making any type of connection, ensure that the type of gas and pressure **of the supply** for which the equipment has been calibrated, (see plate located on the oven, and Appendix A. of this manual), corresponds to the type and the pressure of the gas that is available. This is indicated on the initial regulation label applied to the identification plate. Should these not correspond, refer to paragraph 8.4 to change the regulation.

 Gas appliances have a gas input with a G1/2" conic thread as indicated in the specifications. The connection to the building's gas supply must be made by means of metallic tubing in zinc plated steel or equipment must be connected to the gas mains supply with an easily operated mains copper, exposed to view.

The equipment must be connected to the gas mains supply with an easily operated mains tap.

The connection of the tubing to the equipment must be made with a three piece metal joint to facilitate disassembly.

The strength of the gas tightness on the threaded joint must be ensured with materials specifically declared to be suitable by their manufacturer also for methane and GPL gasses.

For the location of the gas input connections, see Enclosure B.

#### **4.8. Exhaust produced by combustion**

 **This oven produces waste gasses classified as type "A1" (see Enclosure A): equipment not intended for connection to a chimney or flue or a device for the evacuation of the combustion residue into the open air from the room in which the equipment is installed. The drawing in of combustion air and the expelling of combustion exhaust takes place in the room where the oven is installed.**

 **To install type "A1" equipment, rooms in which it is housed must be aerated and ventilated. They must specifically respect the conditions concerning the flow of air necessary for combustion and aeration of these spaces and for the disposal of combustion residue.**

 **ATTENTION!** Carry out the installation of the oven according to the standard defined by the norms in force for this type of equipment in the country in which it is being installed. For more information refer to these norms.

 To find out the nominal heat input of your oven, see Enclosure A When more than one or more cooking units are stacked one on top of another, to calculate the nominal heat input simply sum the power of each single unit.

The area in which the units will be housed must have at least two permanent apertures leading directly through its walls leading into the open air:

- one for the intake of combustion air, ventilating the room
- the other for disposing of combustion gasses, aerating the room.

The two apertures must be in such a position so as not to create a short-circuit in the flow of air: preferably they should be at opposite ends of the room, they must not be obstructed and must be protected with grilles.

The necessary aeration can be achieved naturally or by way of the installation of a forced aeration system depending on the norms in force in the country where the installation is being made for ovens with a type "A1" exhaust.

 **Be aware of the total nominal heat input of the ovens housed in each room in a situation in which more than one unit is being installed.**

 **The Manufacturer cannot answer for damage caused by ignoring these abovementioned norms as well as the information in this manual.**

### **4.9. Checking before starting work**

After completing installation of the unit a series of checks must be carried out, listed as follows:

- check that the various disassembled parts have been assembled.
- Check the power cable.
- Check that the control panel is working.
- Check the integrity of the jointing for gas supply and exhaust tubes.
- Check that the apertures for ventilating the room are adequate.
- Check the nominal capacity of the oven while it is functioning at the exit point of the solenoid valve.
- If present, check that the ventilation hood is working.

## 5. OPERATION

### 5.1. Control panel

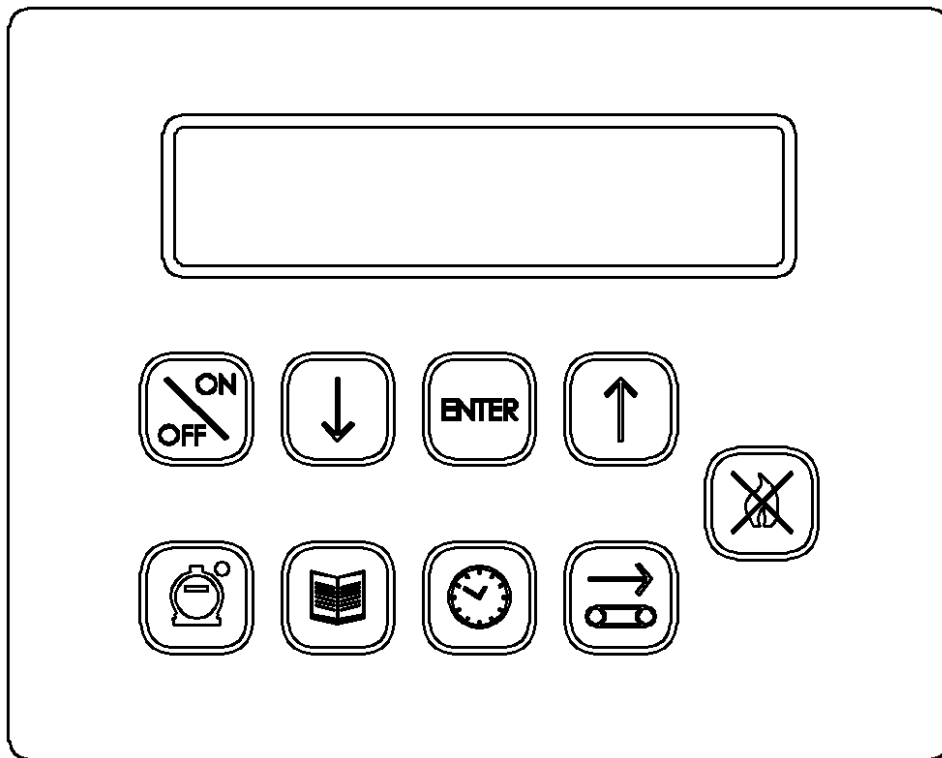

Oven on-off key



Parameter value decrease key



Programme access key



Parameter value increase key



Conveyor start/stop key



Automatic switching on-off key



Reset key



Economy function key



Cooking program setting key.



## 5.2. Functional states of the system

### 5.2.1. Inactive state

In the inactive state (Fig.1-2) the circuit board is supplied with current but all the oven's functions are disabled, apart from those for programming.

The display indicates "OFF", the current time, the day and time the oven will next be automatically switched on (if it set, Fig.2).

In the Fig. 1-2 the letters indicate:

A = current hour

B = current minute

C = day, time, minute the oven will be automatically switched on.

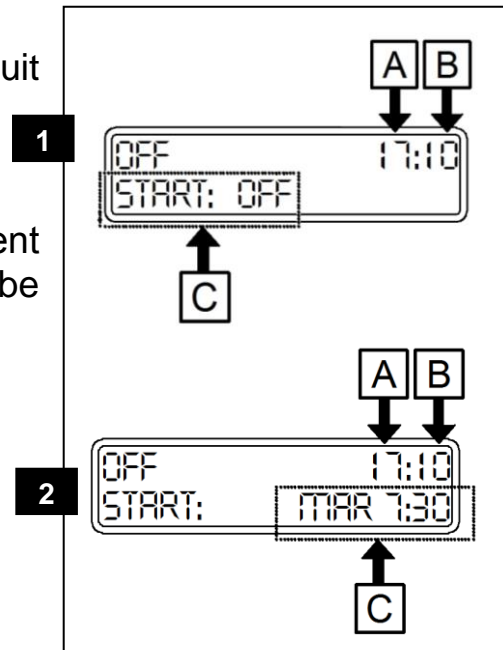

### 5.2.2. State of activity

When the oven is off, the rear illumination on the display is also off.

This turns on when programming is started.

Press the ON key it is entered in a state of activity: it excites the general contactor, the fan turns on and enables the heating of the oven. The backlit display turns on and shows the writing thereon in Fig.3, where:

A = Cooking temperature (°C)

B = Program set

C = Cooking time (minutes : seconds)

D = Operating condition of burner (Max = high flame, Min = low flame, --- = flame off).

E = Economy function active if lit.

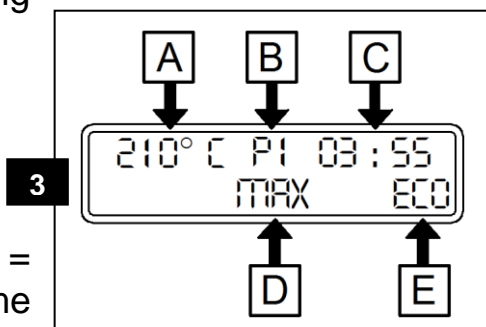

## 5.3. Settings

### 5.3.1. Setting the current time





The current time can be set by the user both when the oven is **only** off.

Press the key  for 3 consecutive seconds to enter the setting mode (Fig.4).

The display indicates (Fig.4), where:

- A = current day
- B = current month
- C = current year
- D = current hour
- E = current minute.

A cursor indicates the data being modified.

Press the  button to decide whether to change the day, month, year, hour or minutes. The value can be adjusted using the keys  and  (Fig.5) and confirmed press the key  again, then move to the next data (Fig.6).

After setting day, month, year, hour and minutes, press the key  to program the current day of the week.

Appears on the display (Fig.7), where:  
F = current day of the week.

### 5.3.2. Setting the language

The display language can be chosen from a list of available options.

To set the language, enter the clock programming mode (see chap. 5.4.1) and confirm the data until appears on the display (Fig.8).

Adjust and confirm using the same procedure as for setting the clock.

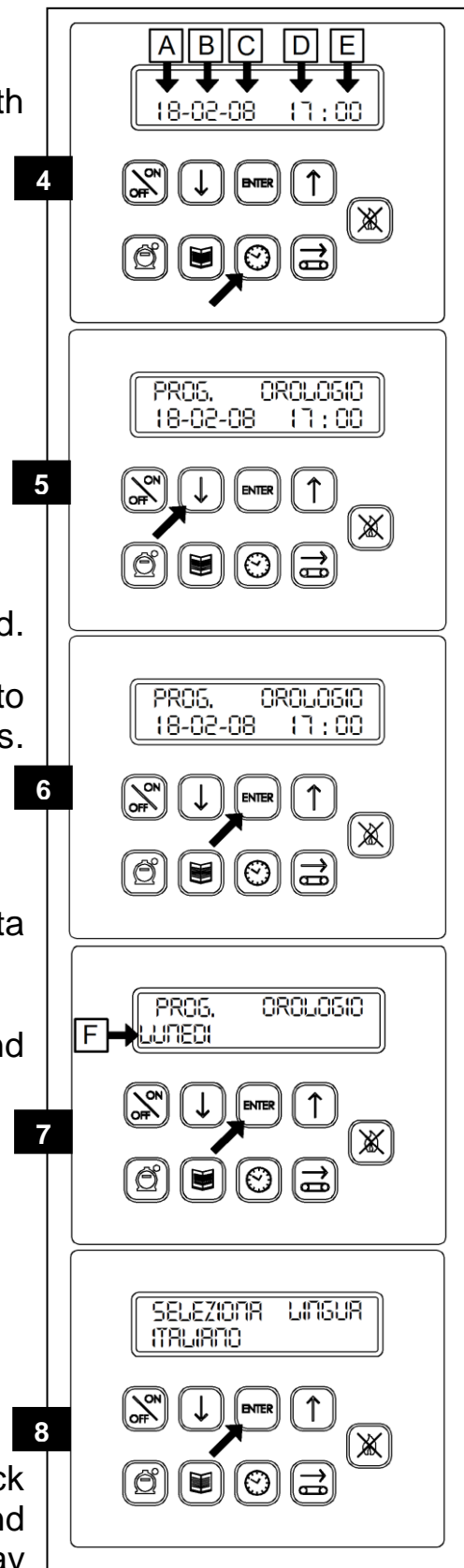

By confirming, you leave the programming mode and return to the previous mode.

## 5.4. Programming

### 5.4.1. Cooking programs

It is possible to manage up to 6 different cooking programs. Each can be set in the following order:

1. Cooking time (minutes : seconds)
2. Temperature setting (°C).

These parameters are normally indicated on the display when the oven is on.

With the oven turned on it is possible to modify all the programs that can be set, with the oven turned off it is only possible to modify the last program that has been used.

Turn on the oven and press the  key to select the programme to modify (Fig.9).

Press the programming access key  to enter the programming mode and move from one parameter to the next (Fig.10).





A horizontal line flashes below the parameter being programmed.

The program that is being modified is always indicated at the top right of the display

To change the value, use the keys to increase and to decrease (Fig.11).

By keeping the key pressed, you increase the speed of data change.

If no key is pressed for more than 5 seconds, the displayed value is **memorised** and the oven automatically leaves the programming mode.

During the programming of the   and  keys are disabled, the  key exits programming mode.

The order of programming is as follows:

1. Cooking time
2. Temperature

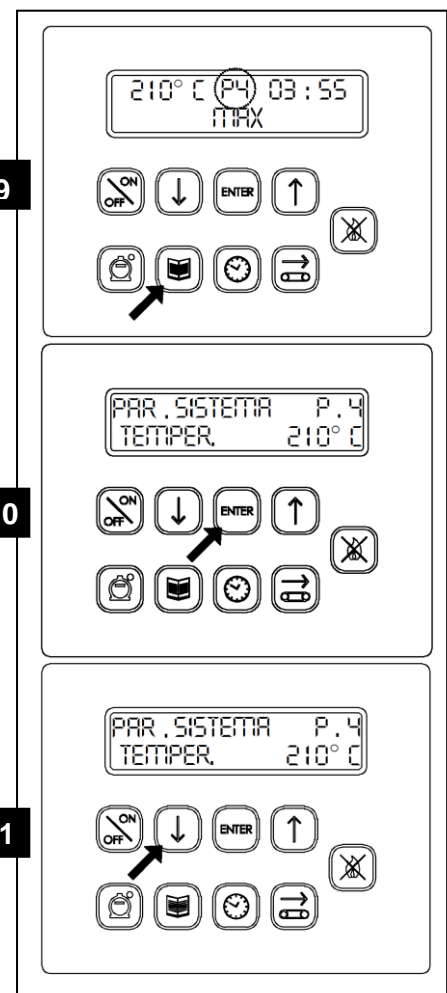

### 5.4.2. *Cooking time adjustment*

The desired cooking time is set directly by the user, and is directly connected to the relevant conveyor speed, which is automatically controlled by the electronic circuit board.

When the oven is switched on, the conveyor is still and the cooking time flashes on the display.

Press the conveyor start/stop key to activate the conveyor (Fig.12).

Conveyor can be started or stopped at any time using the key (Fig.12).

When the conveyor is still, the cooking time flashes.

See the paragraph 5.4.1. to set the cooking time.

### 5.4.3. *Temperature adjustment*

When the oven is on, the real temperature of the cooking chamber is indicated; press the parameter value increase key to display the set temperature (Fig.13).

See the paragraph 5.4.1. to learn how to adjust the set temperature..

The intensity of the flame varies automatically and adjusts according to the operating conditions in the Max, Min or --- positions indicated on the display.

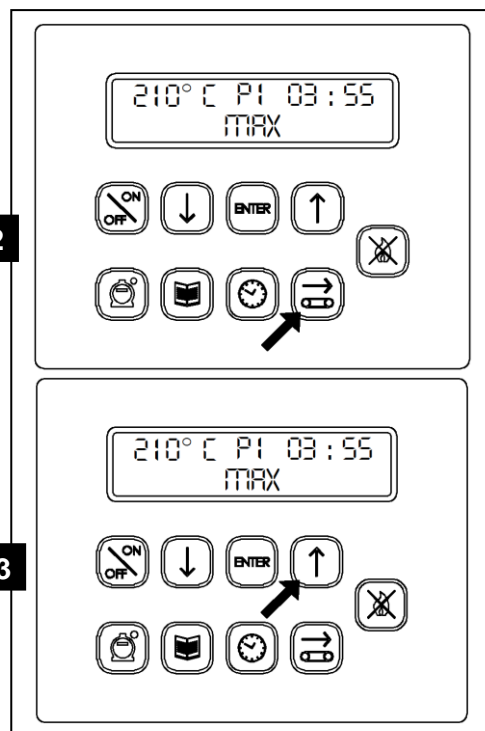



### 5.4.4. Economy Fuction

 The Economy function allows the oven, when left idle, to be kept at a lower temperature than that when it is in use.



This saves energy and consequently money.

Apart from managing the temperature of the oven this can determine whether the wire mesh conveyer moves or not.

 **It is recommended to set a temperature at 50° less than the suitable cooking temperature.**

To access programming of the Economy function: with the oven on, keep the  key pressed for 5 seconds (Fig.14).





A horizontal line under the parameter in programming mode will flash on the display

To change the value use the  and  (Fig.15).

Keeping the key pressed increases the speed that the value changes.



To move onto the next value, press the  key.

If no key is pressed within 5 seconds, the value shown **will be memorised**.

During the programming, the   and  keys are disabled and the  key exits the programming mode

The order of programming is as follows:

1. Eco temperature

2. Mesh in Eco mode ( = enabled;  = disabled).

To activate the economy function, press the  key, the letters “Eco” will appear on the display.

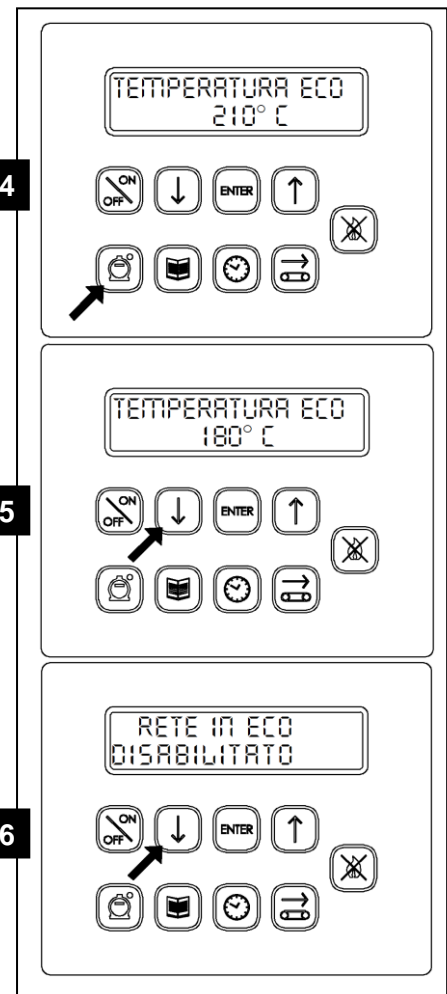



### 5.4.5. Programming switching on

To enter the setting mode for the programmed switching on, press and immediately release the key enable/disable auto power (Fig. 17) with the oven on or off.



At first the state of the automatic switching on (active or inactive) appears on the display (AUTOSTART : ON or OFF).

To enable or disable the program must act respectively on the ignition keys to increase and to decrease (Fig.18).

Once enabled, pressing the button  is displayed on the first day of the week and the figures for the hours and minutes (Fig.19).

To select when to switch the cursor flashing in the figures for hours using the key  and then pressing the buttons to increase and decrease, you set the value (Fig.20).

If you want the oven does not turn on a specific day (eg, closing day), during the time setting, select "OFF" lying between the 23 and 00 using the keys to increase and decrease (Fig.20).

Pressing the button  again will switch to minutes and then pressing the  button again will return the cursor under the day of the week (Fig.19). To move to the next or previous to press the buttons to respectively increase and decrease.

When completed the setting, press again the button  and wait about five seconds. Data is automatically stored and you return to the previous function.

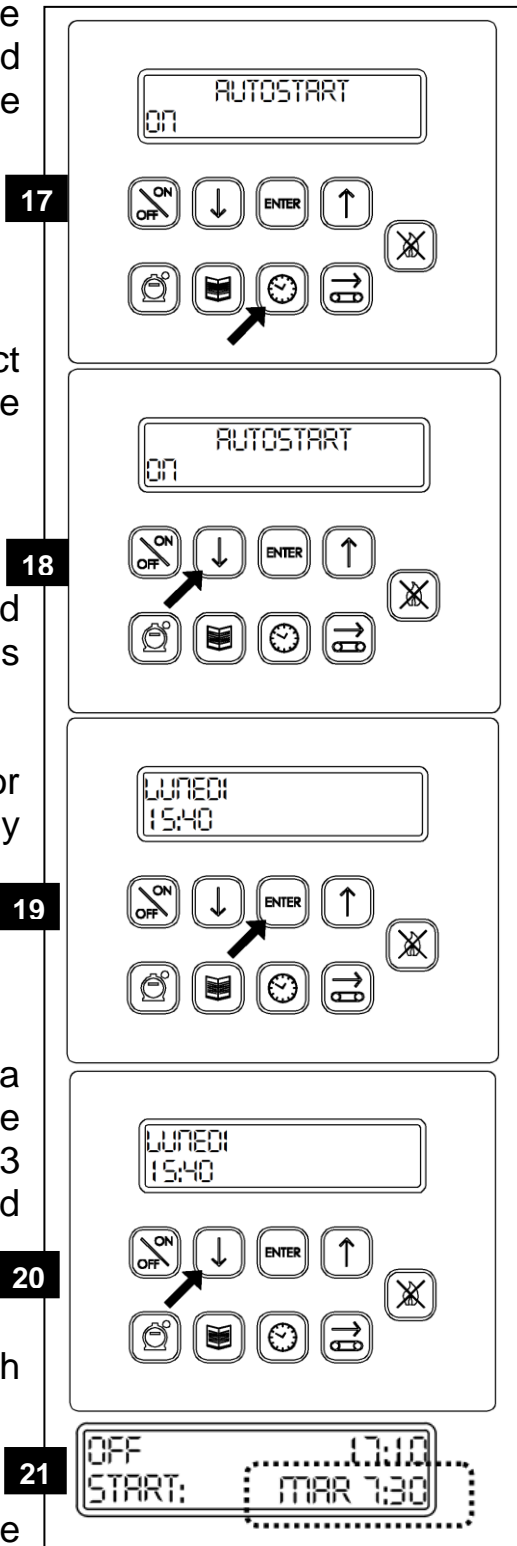

To indicate that the ignition has been enabled, in the idle state the display shows the date and time of the next time (Fig.21). ). If the ignition is turned off, instead of the day and time the message "OFF" appears.

## 5.5. Switching off the oven

Press the key  to switch off the oven (Fig.22).

The heating stops while the air recycling fan and conveyor continue working (if already on) until the temperature drops below 150°C. Then the main contactor de-energizes leaving only the circuit board powered to feed the clock and programmed switching on functions.

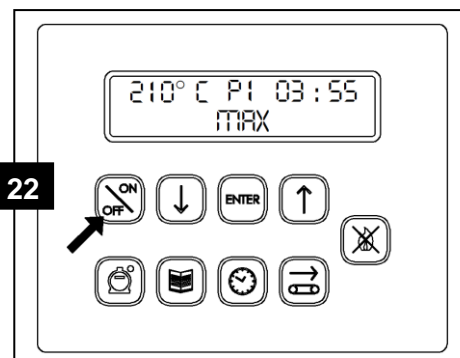

During the switching off phase the rear illumination remains on and the word "OFF" flashes. During this phase the oven can be switched back on and the conveyor can be started or stopped.

To prevent the oven being accidentally switched on, check if the display indicates the desired day and time of switching on, or, if automatic switching on is not desired, that the words "START : OFF" appear.

## 5.6. Alarms

The functioning of the oven is continuously checked. An alarm procedure is activated if any faults arise.

### 5.6.1. "OVER 1"

If the temperature measured by probe 1 exceeds 350°C or if the probe breaks, the temperature value on the display is replaced by the flashing words "OVER 1" and the alarm sounds intermittently.

The alarm can be switched off by pressing the key .

The oven continues working and only the probe 2 is used to measure the temperature. The control temperature is automatically decreased by 40°C.

This variation in the temperature value is effected to correct the only value taken in the hottest part of the oven, and to simulate a value near to the real one previously elaborated by making the average between the hottest and coldest points. This allows the oven to be used even when a probe breaks.

### 5.6.2. "OVER 2"

If the temperature measured by probe 2 exceeds 450°C or if the probe breaks, the temperature value on the display is replaced by the flashing words "OVER 2" and the alarm sounds intermittently.

The alarm can be switched off by pressing the key .



The oven continues working and only probe 1 is used to measure the temperature. The control temperature is automatically raised by 40°C.

This variation in the temperature value is effected to correct the only value taken in the coldest part of the oven and to simulate a value near to the real one previously elaborated by making the average between the hottest and coldest points. This allows the oven to be used even when a probe breaks.

### 5.6.3. “OVER”

If the temperature measured by the probe 1 exceeds 350°C and, at the same time, probe 2 exceeds 450°C, the temperature value on the display is replaced by the flashing word “OVER” and the alarm sounds intermittently.

You can switch off the alarm by pressing the key .

 Necessary to call in specialists to restore functionality

### 5.6.4. “BELT”

When the conveyor motor is broken or sends wrong signals to the circuit board, the word “BELT” flashes on the display and the alarm sounds intermittently.

This means that the cooking time does not correspond to the set value and that specialized personnel are required to reset the functions of the oven.

### 5.6.5. “FAN”

If the pressure regulator fails for 5 consecutive seconds when the fan is on, the temperature value on the display is replaced by the flashing word “FAN”, the buzzer sounds intermittently and the oven heating (if on) switches off. The alarm switches off automatically when the pressure regulator contact is re-established or the oven is switched off (after the switching off phase). The correct functioning of the pressure regulator should then be checked.

While the alarm sounds, fan and conveyor (if on) remain activated.

The buzzer can be silenced by pressing the key .

### 5.6.6. “PRESS”

If there is no pressure regulator (before switching on the fan), the word OFF is replaced by the flashing word “PRESS”, the alarm sounds intermittently and the switching on procedure terminates.

To reset the functioning of the oven, check that the pressure regulator is working properly. To do this, check that the pipes are connected without any constriction. If necessary, adjust the calibration with the screw located



at the centre of the pressure regulator. The buzzer can be silenced by pressing the key .

### **5.6.7. “FLAME”**

If the gas control centre cannot detect a flame while the burner is on or being switched on, an alarm is given on the display through the flashing word “FIAMMA” (“FLAME”), accompanied by the intermittent sound of the buzzer. The oven stops working.

Press the key  to try and light the burner again.

In case of failure, the alarm sounds again.

The buzzer can be silenced by pressing the key .



If, after having pressed the reset button  the oven fails to turn on, check the gas connection (for inst. if the valve on the feeding pipe is open) and that the flame detector is in contact with the flame while lighting.

At the first ignition this alarm may often occur due to the presence of air in the feeding pipe. Try lighting repeatedly until the air has left the pipe completely.

### **5.6.8. “BATTERY”**

When the buffer battery installed on the main electronic board is exhausted, an alarm is activated on the display together with the flashing writing "BATTERY" and the acoustic signal plays in intermittent way. To replace the battery see paragraph 8.3.

## 6. USE

 During cooking or at the end of cooking some of the oven's surfaces reach dangerous temperatures. The  symbol warns of this danger. Never touch these surfaces and only use the proper handle.

### 6.1. Preparation for use and before turning

If the unit has just been installed or if it has not been used for several days before using it to work you need to clean it completely food as described in Chapter cleaning, to eliminate manufacturing waste, accumulations of dust or other substances that may contaminate food.

#### 6.1.1. Ignition Control Panel

Press the  (Fig.1), part of the fan. After 20 seconds the message appears on the display "FLAMES" and activates the audible signal.

#### 6.1.2. Settings and start cooking

Select the desired cooking program by pressing the button  (Fig.2). For programming, see section 5.4.1.

Open the gas cock and press the reset-button  (Fig.3) to light the burner.

If at the end of the 40/50 seconds the writing "FLAME" appears on the display, check that the gas pipe is connected properly and that the gas cock is open. Anyway, it may happen that a failure occurs during the first starting trial, due to the presence of air in the gas pipes.

Wait 5 minutes and press again on reset button (Fig.3) to activate the burner.

After setting the cooking time and temperature required to proceed to the activation of the belt movement using the button (Fig.4).

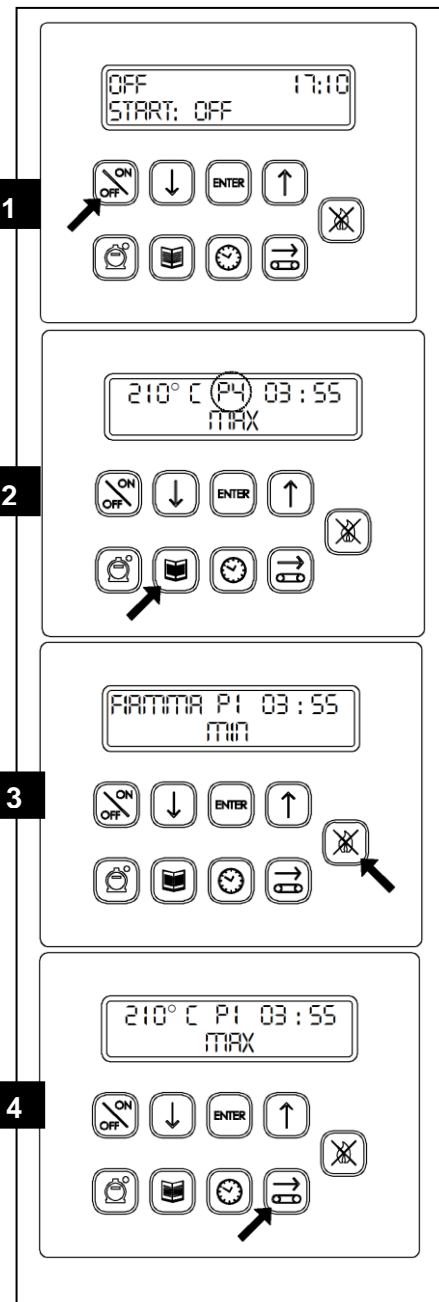

### 6.1.3. How to turn off the oven

At the end of each working day press the button  (Fig.5).

The heating is turned off while the blower and the recirculation of the belt, if activated, will continue to operate until the temperature has dropped to below 150°C, after which de-energizes the contactor generally leaving only the supplied tab to enable the clock and power-programmed functions.

During the shutdown the backlight stays on and the word "OFF" blinks. At this stage you can still turn on the oven and start or stop the movement of the belt. To avoid unwanted ignition, check that the display indicates the exact date and time desired power or, if you do not want to use the automatic ignition, which appears the word "START: OFF"

When the oven is not used for a long period (for example until the day after) you must position the switches ON/OFF in OFF position and close the gas cock.

For longer periods of inactivity (for instance holidays closure) it is advisable to turn off the main switch on the electric panel, but only when the chamber fans have stopped.

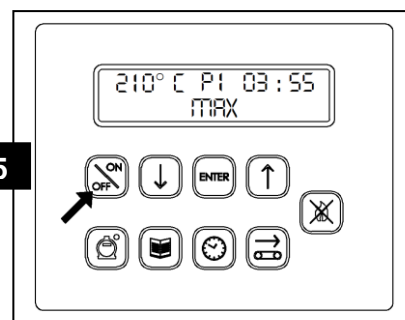

## 7. SAFETY WARNINGS

### 7.1. Prohibited actions and obligations towards the prevention of accidents

 **Read the warnings listed in this chapter carefully. They give important indications concerning safety.**

It is forbidden to install accessories that do not conform with safety standards.

Have the appliance inspected regularly by a qualified technician to guarantee your safety.

#### 7.1.1. *Warnings for installers*

Check that the preparation for housing the appliance conforms to the local National and European regulations.

- Follow all the indications in this manual
- Do not make any overhead electrical connections using provisional or non-insulated cabling.
- Check that this electrical equipment is efficiently earthed.
- Always use personal safety devices and other means of protection foreseen by the law.

#### 7.1.2. *Warnings for users*

The environmental conditions of the place where the appliance is to be installed must have the following characteristics:

- the area must be dry;
- be distant from sources of heat or water;
- have adequate ventilation and illumination conforming to the norms of hygiene and safety foreseen by the laws in force;
- The floor must be level and compact to facilitate thorough cleaning;
- there must not be any obstacles of any kind in the immediate vicinity that could compromise the normal ventilation of the area;

Apart from this the user must:

- make sure that children do not come close to the equipment whilst it is functioning;
- observe the rules laid out in this manual;
- not use the machine inappropriately but stick scrupulously to the use for which it was designed;
- not remove or interfere with the equipment's safety mechanisms;
- keep the safety systems in good working order;

- carry out all working procedures with the utmost safety and calm;
- respect the instructions and warnings highlighted by the signs on the equipment. These signs are to prevent accidents and must always be perfectly legible. Whenever they are damaged or illegible it is obligatory to replace them by requesting the original part from the manufacturer;
- disconnect the electricity supply after the appliance has been used,
- before carrying out cleaning or maintenance.

 **ATTENTION! Whilst the machine is working it is forbidden to remove the safety protection seeing that its parts are moving. These could cause injury to hands.**

 In the case of fire do not use liquid extinguishing agents but only those in powder form

### **7.1.3. Warnings for the maintenance operator**

 Disconnect the electricity supply before working on electrical or electronic parts or connections.

- Always use personal safety devices and other means of protection.
- Before beginning any maintenance operations make sure that the equipment has cooled down if it has just been used.
- Should one of the safety devices not work or not be set correctly the appliance must be considered out of order.

## 8. CLEANING

 **Cleaning should be carried out with the equipment turned off and at room temperature having taken the precaution of disconnecting the electricity supply.**

Weekly maintenance can be carried out by the equipment's operator given that they observe the safety procedures set out in this manual. A simple but regular and careful clearing guarantees efficient performance and the normal functioning of this equipment.

 Always use person protection gear and always use tools that are appropriate for maintenance.

 Do not direct jets of water onto the equipment for clearing as these can penetrate through to and damage the electrical system with the consequent risk of electrocution and the equipment starting up unexpectedly.

 Do not use abrasive tools (abrasive sponges, etc.) because these will cause the stainless steel and glass parts to become opaque and will, quite quickly, remove the protective layer of aluminum coated sheet steel, at which point it will start to rust.

 Do not use detergents containing chlorine.

 **After the maintenance operation or repair has been carried out, reinstall all physical protection and reactivate all safety devices before putting the machine back into service.**

### 8.1. Cleaning removable parts

 To avoid that at some points accumulate dirt or detergent residue that may contaminate processed products, help with tools not sharp or small brushes.

It is advisable to wash the various removable parts before food residues on them dry and go hard.

Cleaning of the drawers of entry and exit should be performed every 4 hours of operation.

## 8.2. Cleaning of external parts

 The crystals are particularly sensitive to sudden changes in temperature that can cause them to break into tiny fragments. Do not handle the crystals and not bring them into contact with the water until they are at room temperature.

 Use a soft wet sponge with a light not abrasive detergent to clean external stainless steel or painted surfaces.

## 8.3. Cleaning the baking chambers

To access the internal components of the baking chamber, proceed as follows:

1. Disconnect the power supply to the oven by turning off the mains. Use the switch on the mains fuse box.
2. Remove the drawers at the entrance and exit of the wire mesh conveyor belt.
3. Remove the casing covering the conveyor belt transmission joint freeing it from its attachment with an upward movement.
4. Rotate the wire mesh conveyor until the drive shaft pivot corresponds with the transmission joint notch.
5. Slide the joint towards the control panel freeing it from the conveyor belt drive shaft.
6. Raise the shutters at the entrance and exit to the point of maximum aperture.
7. Lift the wire mesh conveyor belt from both ends and remove it in the direction of the controls.
8. Open the side hatch and unbolt the nuts using a number 8 spanner. Making sure to wear a pair of heavy duty gloves to avoid getting scratched from sharp metal corners and take out the diffusers.
9. To clean the removable parts, follow the instructions contained in paragraph 8.1. To clean inside the baking chamber, remove food deposits with a dustpan and brush or with a vacuum cleaner before cleaning the metal surfaces with a sponge wetted with water and a non abrasive or corrosive detergent, then wash these surfaces with a sponge soaked in clean water.
10. After cleaning the equipment reassemble all the components by following the instructions above in reverse order.

It is recommended to clean the oven after it has been in operation for more than 200 hours.

## 9. MAINTENANCE

 **WARNING!** These use and maintenance instructions are intended only for staff qualified for the installation and maintenance of electrical and gas equipment. Maintenance by other persons may cause damage to the equipment, persons, animals or things.

 In the majority of cases it is necessary to remove the fixed guards in order to carry out repairs and checks. This also renders the voltage cables accessible.

**Before carrying out any maintenance operations check that the equipment's feed cable plug is disconnected from the switchboard. Put the plug in a place where the maintenance operator can easily ascertain that it has been disconnected during all of the work done with the guards removed.**

### 9.1. Error indicator

The electronic thermo-regulator can detect various malfunctions, for details see 5.6.

### 9.2. Safety thermostat

If the chamber temperature exceeds 500°C., the safety thermostat is activated and closes the gas valve. The safety thermostat is reset manually and is at the external side of the oven electric board or on the left side of the control panel under the conveyor.

To correct the error, disconnect the plug from the electric panel, close the gas valve and wait until the chamber cools down.

Remove the right side panel of the electric board and press the red push-button on the thermostat. Reset will take place only when the chamber temperature has gone below the temperature of 500°C.

 Since the safety thermostat is activated only in case of serious damages (for instance if the gas valve ON/OFF is blocked open), before starting the oven again check carefully the good working of the same and perform the required reparations.



### 9.3. Replace battery

The alarm message “BATTERY” has to be referred to the buffer battery of the electronic base board, which is over and must be replaced.

The message on the display is given together with an alarm, which intermittently sounds.

Switch off the alarm sound by pressing the key  .

For replacing the battery it is necessary to remove the fixed guards on the electric panel.

 Before carrying out any maintenance operations check that the main cable plug is disconnected from the power.

The battery is located in the middle of the electronic base board, see fig. 8.1; for replacing the battery, please follow carefully the steps listed below:

- switch off the oven and disconnect it from the main power;
- remove the guards of the electronic panel;
- replace the old battery with a new one;
- connect the oven to the power and switch it on;
- set the current time (see paragraph 5.4.1);
- switch off the oven again and disconnect it from the main power;
- connect the oven to the power and switch it on again.

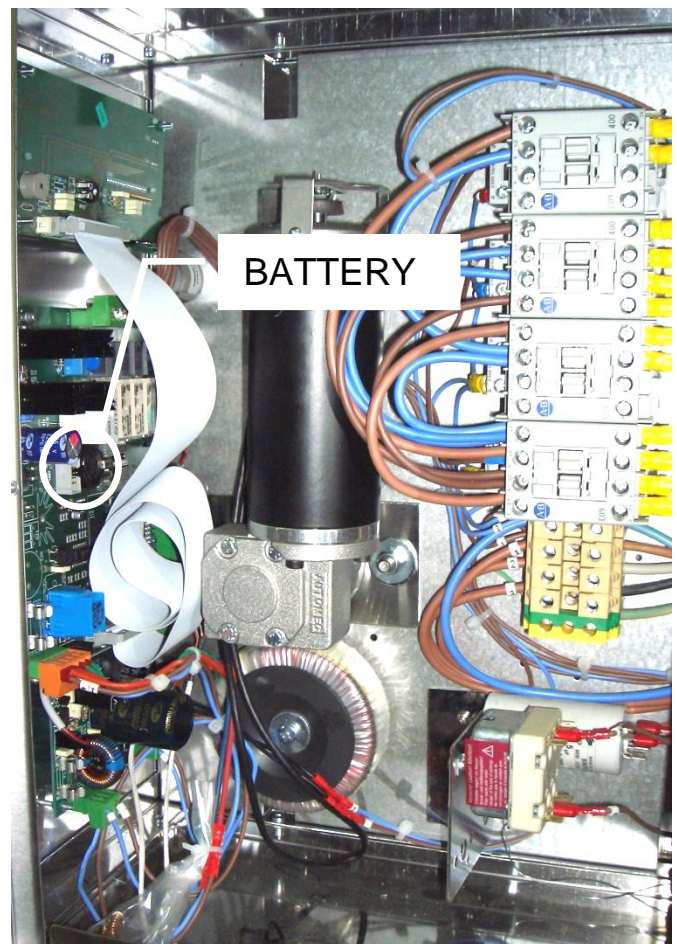

Fig. 8.1 Electronic panel, position of the BATTERY.

Now everything is ok, your battery won't give any other alarm; and you can start working.

**In case the “BATTERY” alarm still remains after replacing the battery, please don't forget to set the clock of the base board (see**

**paragraph 5.3.1).** Then disconnect the oven from the main power and connect it again.

This operation permits to reset the base board and delete any other alarms in memory.

#### 9.4. Adjustment to different gas type

 **Warning!** The maintenance instruction contained here are for the use of qualified maintenance and service personnel only. Three steps have to be performed to have the gas conveyor oven adjusted to work with a gas type different from the one shown on the initial data label:

1. replacement of burner injectors.
2. Adjustment of minimum power.
3. Removal of the old data label and application of the new one.

 Carefully perform all a.m. steps, as only in this way the baking oven can be considered safe.

##### 9.4.1. Replacement of burner injector

1. Disconnect the plug from the electric panel and close the gas cock.
2. Open the safety enclosure of the burner compartment.
3. Take down the burner after having disconnected the gas pipe and the electric wiring.
4. Remove the ignition and flame detection electrodes
5. Unscrew the burner pipes using a screwdriver.
6. Unscrew the injectors using a number 12 spanner, and replace them with the new ones.
7. Repeat the above operations in reverse, checking carefully the tightening of nozzles and of gas feeding pipes.

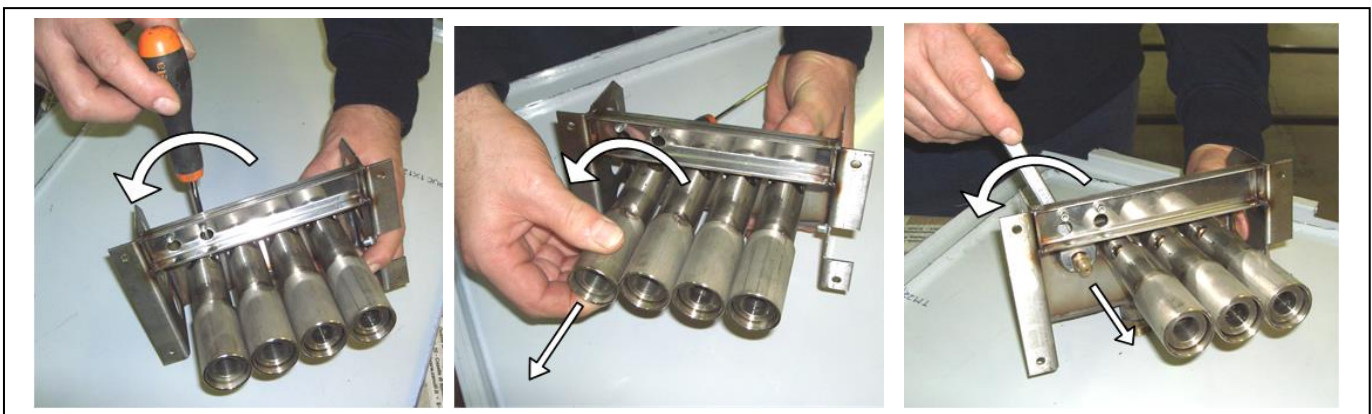

### 9.4.2. Adjustment of minimum power

1. Remove the safety enclosure of the burner compartment.
2. Remove the sealing screws placed before and after the gas valve and connect two vertical tube manometer (Fig.1).
3. Turn on the oven and set temperature of 200 ° C. When the burner is lit, the flame intensity is highest, verify that the pressure indicated by pressure gauge is connected to supply provided for the adjustments made, otherwise proceed with the regulation through the hexagon A (wrench of 10, Fig.2).
4. Wait until the oven ports on the phase of the minimum and adjust the pressure of the minimum through the screw B (Philips screwdriver, Fig.2).

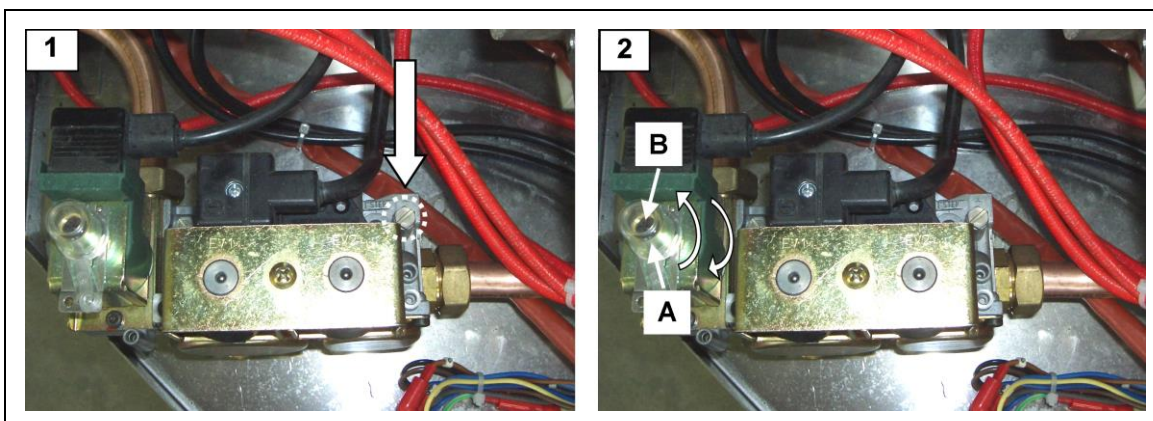
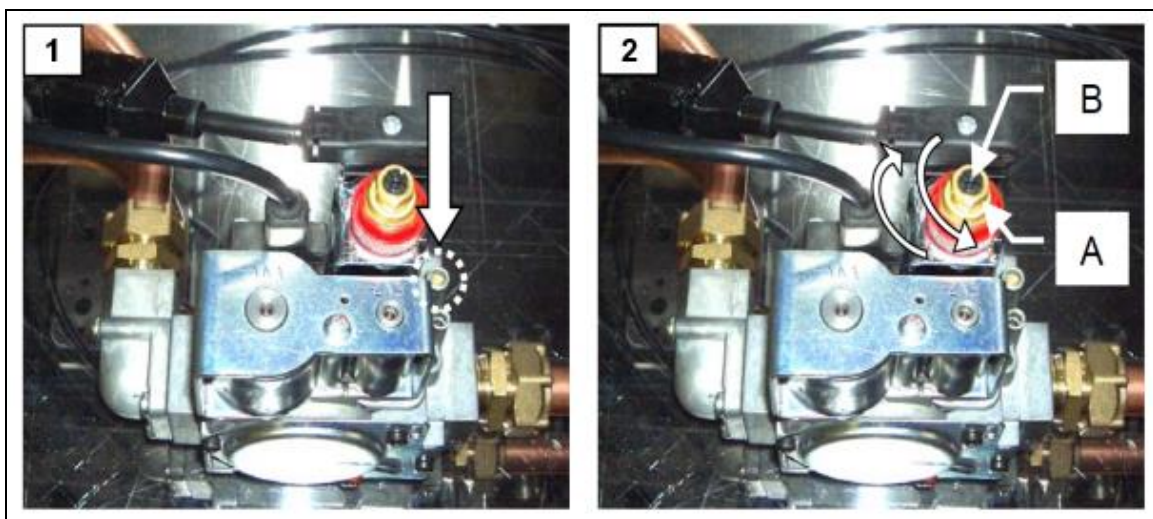

### 9.4.3. Application of new label

1. Remove the old label on the back of the conveyor oven and clean the area by means of a cloth dampened with petrol.
2. Apply the new label, showing the kind of gas pressure for which the oven has been changed (the adapting kit, with new label, instructions and nozzles, is supplied according to the gas type and pressure).



## 10. DECOMMISSIONING AND DEMOLITION

Before proceeding with the decommissioning disconnect the electrical supplies to the equipment and any other connections there may be and then move the modules using suitable means such as: forklift trucks, hoists, and so on.

The machines are made up of the following materials: stainless steel, coated steel, glass, ceramic material, rock wool and electrical parts.

For the purposes of demolition therefore the materials have to be separated in observance with the norms in force in the place where the machine is being dismantled.



**Separate collection. This product must not be disposed of with normal household waste. Local RAEE regulations may provide for separate collection of this kind of product.**

---

# **SYNTHESIS**

## **08/50 V PW GAS**

**Allegati tecnici**  
**Technical enclosures**  
*Anexos técnicos*  
*Fichiers techniques joints*  
**TECHNISCHE ANLAGEN**



## A. Caratteristiche tecniche Synthesis 08/50 PW gas

### A. Technical specifications Synthesis 08/50 PW gas

### A. Especificaciones técnicas Synthesis 08/50 PW gas

ITALIANO	ENGLISH	ESPAÑOL	
<b>Peso</b>	Weight	<i>Peso</i>	200 kg
<b>Dimensioni esterne</b>	Overall dimensions	<i>Dimensiones externas</i>	1260x1750x490 mm
<b>Larghezza rete</b>	Conveyor width	<i>Amplitud red</i>	500 mm
<b>Lunghezza rete</b>	Conveyor length	<i>Longitud red</i>	1670 mm
<b>Lunghezza camera</b>	Chamber length	<i>Longitud cámara</i>	850 mm
<b>Capacità produttiva</b>	Output per hour	<i>Capacidad productiva</i>	20-17 (60-50 pizzas/h ø 30 cm) Kg/h
<b>Alimentazione elettrica</b>	Electrical power	<i>Alimentación eléctrica</i>	<b>Monofase</b> <i>Single-Phase</i> <i>Monofásica</i>
<b>Tensione</b>	Voltage	<i>Tensión</i>	230 VAC
<b>Frequenza</b>	Frequency	<i>Frecuencia</i>	50 o 60 Hz
<b>Corrente a 230V 50Hz</b>	Current at 230V 50Hz	<i>Corriente a 230V 50Hz</i>	2 A
<b>Potenza elettrica tot.</b>	Total electrical power	<i>Potencia eléctrica total</i>	450 W
<b>Collegamento elettrico</b>	Electrical connection	<i>Conexión eléctrica</i>	<b>Cavo bipolare senza spina</b> - Bi-polar cable, without plague - <i>Cable bipolar sin enchufe</i>
<b>Lunghezza cavo</b>	Cable length	<i>Longitud cable</i>	2 m
<b>Sezione conduttori</b>	Wire section	<i>Sección conductores</i>	1.5 mm <sup>2</sup>
<b>Tipo di bruciatore</b>	Burner type	<i>Tipo de quemador</i>	<b>Aspirato</b> <i>Aspirate</i> <i>Aspirado</i>
<b>Categoria</b>	Type	<i>Categoría</i>	II <sub>2H3+</sub>

**Diametro ugello in funzione del gas e della pressione** – Injectors diameter according to gas and pressure - *Diámetro inyector en función del gas y de la presión*

<b>G20 - 20 mbar</b>	G20 - 20 mbar	<i>G20 - 20 mbar</i>	2,35 mm
<b>G25 - 25 mbar</b>	G25 - 25 mbar	<i>G25 - 25 mbar</i>	2,35 mm
<b>G25 - 20 mbar</b>	G25 - 20 mbar	<i>G25 - 20 mbar</i>	2,35 mm
<b>G30 - 28...30 mbar</b>	G30 - 28...30 mbar	<i>G30 - 28...30 mbar</i>	1,35 mm
<b>G30 - 50 mbar</b>	G30 - 50 mbar	<i>G30 - 50 mbar</i>	
<b>G31 - 30...37 mbar</b>	G31 - 30...37 mbar	<i>G31 - 30...37 mbar</i>	1,35 mm
<b>G31 - 50 mbar</b>	G31 - 50 mbar	<i>G31 - 50 mbar</i>	

**Pressione minima all'ugello in funzione del gas e della pressione di alimentazione**

Minimum pressure and injector according to gas and pressure

*Presión mínima al inyector en función del gas y de la presión de alimentación*

<b>G20 - 20 mbar</b>	G20 - 20 mbar	<i>G20 - 20 mbar</i>	3,0 mbar
<b>G25 - 25 mbar</b>	G25 - 25 mbar	<i>G25 - 25 mbar</i>	4,5 mbar
<b>G25 - 20 mbar</b>	G25 - 20 mbar	<i>G25 - 20 mbar</i>	4,5 mbar
<b>G30 - 28...30 mbar</b>	G30 - 28...30 mbar	<i>G30 - 28...30 mbar</i>	8,0 mbar
<b>G30 - 50 mbar</b>	G30 - 50 mbar	<i>G30 - 50 mbar</i>	
<b>G31 - 30...37 mbar</b>	G31 - 30...37 mbar	<i>G31 - 30...37 mbar</i>	8,0 mbar
<b>G31 - 50 mbar</b>	G31 - 50 mbar	<i>G31 - 50 mbar</i>	

**Pressione massima all'ugello in funzione del gas e della pressione di alimentazione**

Maximum pressure and injector according to gas and pressure

*Presión máxima al inyector en función del gas y de la presión de alimentación*

<b>G20 - 20 mbar</b>	G20 - 20 mbar	<i>G20 - 20 mbar</i>	10 mbar
<b>G25 - 25 mbar</b>	G25 - 25 mbar	<i>G25 - 25 mbar</i>	15 mbar
<b>G25 - 20 mbar</b>	G25 - 20 mbar	<i>G25 - 20 mbar</i>	15 mbar
<b>G30 - 28...30 mbar</b>	G30 - 28...30 mbar	<i>G30 - 28...30 mbar</i>	-
<b>G30 - 50 mbar</b>	G30 - 50 mbar	<i>G30 - 50 mbar</i>	27 mbar
<b>G31 - 30...37 mbar</b>	G31 - 30...37 mbar	<i>G31 - 30...37 mbar</i>	27 mbar

<b>G31 - 50 mbar</b>	G31 - 50 mbar	<i>G31 - 50 mbar</i>	27 mbar
<b>Collegamento gas</b>	Gas connection	<i>Conexión gas</i>	<b>(filettatura gas conica)</b> (taper pipe thread) (rosca gas cónica)
<b>Tubo</b>	Ø Pipe	<i>Tubo</i>	1/2"
<b>Consumo - Consumption - Consumo</b>			
<b>Potenza massima bruciatore</b>	Nominal thermal capacity	<i>Potencia máxima quemador</i>	13,9 kW
<b>Portata G20</b>	Consumption G20	<i>Portada G20</i>	1,471 m <sup>3</sup> /h
<b>Portata G25</b>	Consumption G25	<i>Portada G25</i>	1,711 m <sup>3</sup> /h
<b>Portata G30</b>	Consumption G30	<i>Portada G30</i>	1,096 Kg/h
<b>Portata G31</b>	Consumption G31	<i>Portada G31</i>	1,080 Kg/h
<b>Potenza minima bruciatore</b>	Reduced thermal capacity	<i>Potencia mínima quemador</i>	7,6 kW
<b>Portata G20</b>	Consumption G20	<i>Portada G20</i>	0,804 m <sup>3</sup> /h
<b>Portata G25</b>	Consumption G25	<i>Portada G25</i>	0,935 m <sup>3</sup> /h
<b>Portata G30</b>	Consumption G30	<i>Portada G30</i>	0,595 Kg/h
<b>Portata G31</b>	Consumption G31	<i>Portada G31</i>	0,591 Kg/h
<b>Scarico fumi - Flue connection - Descarga humos</b>			
<b>Tipo</b>	Type	<i>Tipo</i>	A1
<b>Ricambio d'aria</b>	Air exchange	<i>Recambio de aire</i>	48 m <sup>3</sup> /h
<b>Controllo fiamma</b>	Flame control	<i>Control llama</i>	<b>Controllo elettronico senza fiamma pilota</b> Electronic without pilot <i>Control electrónico sin llama piloto</i>
<b>Tempo di sicurezza</b>	Safety time	<i>Tiempo de seguridad</i>	<5 s
<b>Accensione fiamma</b>	Flame ignition	<i>Encendido llama</i>	<b>A scintilla - Hot surface</b> - <i>A chispa</i>
<b>Controllo cottura</b>	Baking control	<i>Control cocción</i>	<b>Elettronico computerizzato</b> Electronic computerized <i>Electrónico computerizado</i>
<b>Unità di misura temperatura</b>	Temperature measuring unit	<i>Unidad de medida temperatura</i>	°C
<b>Massima temp. impostabile</b>	Maximum possible temperature	<i>Máxima temperatura configurable</i>	320 °C
<b>Controllo intensità fiamma</b>	Flame power control	<i>Control intensidad llama</i>	<b>Automatico o manuale</b> Automatic or manual <i>Automático o manual</i>
<b>Segnalazione errori</b>	Errors indicator	<i>Señalaciones errores</i>	<b>Mediante display e segnalazione acustica</b> By means of display and acoustic alarm <i>Mediante display y señalación acústica</i>
<b>Condizioni ambientali - Environment - Condiciones ambientales</b>			
<b>Temperatura</b>	Temperature	<i>Temperatura</i>	0 – 40 °C
<b>Umidità massima</b>	Maximum humidity	<i>Humedad máxima</i>	95% <b>senza condensa</b> without condensation <i>sin condensación</i>
<b>Livello di rumore</b>	Noise level	<i>Nivel acústico</i>	< 70 decibel



## A. Spécifications techniques Synthesis 08/50 PW gas

### A. TECHNISCHE SPEZIFIKATIONEN SYNTHESIS 08/50 PW GAS

FRANÇAIS	DEUTSCH	
Poids	GEWICHT	200 kg
Dimensions ext..	AUßENABMESSUNGEN	1260x1750x490 mm
Largeur ruban transp.	NETZBANDBREITE	500 mm
Longueur ruban transp.	NETZBANDLÄNGE	1670 mm
Longueur chambre	BACKKAMMERLÄNGE	850 mm
Capacité productive	STUNDENLEISTUNG	20-17 (60-50 pizzas/h ø 30 cm) Kg/h
Alimentation électr.	STROMVERSORGUNG	<b>Monophase</b> EINPHASIG
Tension	SPANNUNG	230 VAC
Fréquence	FREQUENZ	50 o 60 Hz
Courant à 230 V 50 Hz	STROM ZU 230V 50HZ	2 A
Puissance électrique totale	ELEKTRISCHE LEISTUNG INSGESAMT	450 W
Connexion électrique	ELEKTRISCHER ANSCHLUSS	<b>Câble bipolaire sans fiche - ZWEIPOLIGES STECKERLOSES KABEL</b>
Longueur du câble	KABELLÄNGE	2 m
Section conducteurs	LEITERQUERSCHNITT	1.5 mm <sup>2</sup>
Type de brûleur	BRENNERTYP	<b>Aspiré</b> ATMOSPHÄRISCH
Catégorie	KATEGORIE	II <sub>2H3+</sub>

#### Diamètre de la buse en fonction du gaz et de la pression

DURCHMESSER DER DÜSE LAUT DEM GASTYP UND DEM DRUCK

G20 - 20 mbar	G20 - 20 mbar	2,35 mm
G25 - 25 mbar	G25 - 25 mbar	2,35 mm
G25 - 20 mbar	G25 - 20 mbar	2,35 mm
G30 - 28...30 mbar	G30 - 28...30 mbar	1,35 mm
G30 - 50 mbar	G30 - 50 mbar	
G31 - 30...37 mbar	G31 - 30...37 mbar	1,35 mm
G31 - 50 mbar	G31 - 50 mbar	

#### Pression minimale à la buse en fonction du gaz et de la pression d'alimentation

MINIMALDRUCK AN DER DÜSE LAUT DEM GASTYP UND DEM VERSORGUNGSDRUCK

G20 - 20 mbar	G20 - 20 mbar	3,0 mbar
G25 - 25 mbar	G25 - 25 mbar	4,5 mbar
G25 - 20 mbar	G25 - 20 mbar	4,5 mbar
G30 - 28...30 mbar	G30 - 28...30 mbar	8,0 mbar
G30 - 50 mbar	G30 - 50 mbar	
G31 - 30...37 mbar	G31 - 30...37 mbar	8,0 mbar
G31 - 50 mbar	G31 - 50 mbar	

#### Pression maximale à la buse en fonction du gaz et de la pression d'alimentation

MAXIMALDRUCK AN DER DÜSE LAUT DEM GASTYP UND DEM VERSORGUNGSDRUCK

G20 - 20 mbar	G20 - 20 mbar	10 mbar
G25 - 25 mbar	G25 - 25 mbar	15 mbar
G25 - 20 mbar	G25 - 20 mbar	15 mbar
G30 - 28...30 mbar	G30 - 28...30 mbar	-
G30 - 50 mbar	G30 - 50 mbar	27 mbar
G31 - 30...37 mbar	G31 - 30...37 mbar	27 mbar
G31 - 50 mbar	G31 - 50 mbar	27 mbar
Connexion gaz	GASANSCHLUSS	ISO 7 – <b>(filettatura gas conica)</b> (KONISCHES GASGEWINDE)
Tube	ROHR	1/2"

**Consommation - VERBRAUCH**

<b>Puissance maximale brûleur</b>	MAXIMALE BRENNERLEISTUNG	13,9 kW
<b>Portata G20</b>	CONSUMPTION G20	1,471 m <sup>3</sup> /h
<b>Portata G25</b>	CONSUMPTION G25	1,711 m <sup>3</sup> /h
<b>Portata G30</b>	CONSUMPTION G30	1,096 Kg/h
<b>Portata G31</b>	CONSUMPTION G31	1,080 Kg/h
<b>Puissance minimale brûleur</b>	MINIMALE BRENNERLEISTUNG	7,6 kW
<b>Portata G20</b>	CONSUMPTION G20	0,804 m <sup>3</sup> /h
<b>Portata G25</b>	CONSUMPTION G25	0,935 m <sup>3</sup> /h
<b>Portata G30</b>	CONSUMPTION G30	0,595 Kg/h
<b>Portata G31</b>	CONSUMPTION G31	0,591 Kg/h

**Évacuation fumées - RAUCHAUSLASS**

<b>Type</b>	TYP	A1
<b>Aération</b>	LUFTWECHSEL	48 m <sup>3</sup> /h
<b>Contrôle flamme</b>	FLAMMENKONTROLLE	<b>Contrôle électronique sans flamme pilote</b> ELEKTRONISCHE KONTROLLE OHNE PILOTFLAMME
<b>Temps de sécurité</b>	SICHERHEITZEIT	<5 s
<b>Allumage flamme</b>	FLAMMENZÜNDUNG	<b>À étincelle - Mittels Funken</b>
<b>Contrôle cuisson</b>	BACKKONTROLLE	<b>Électronique informatisé</b> ELEKTRONISCH COMPUTERISIERT
<b>Unité de mesure température</b>	TEMPERATUR-MAßEINHEIT	°C
<b>Température max. programmable</b>	MAXIMAL EINSTELLBARE TEMPERATUR	320 °C
<b>Contrôle intensité de la flamme</b>	KONTROLLE DER FLAMMENINTENSITÄT	<b>Automatique ou manuel</b> AUTOMATISCH ODER MANUELL
<b>Signalisation d'erreur</b>	FEHLERMELDUNG	<b>Grâce au display et signal acoustique</b> MITTELS DISPLAY UND SIGNALTON

**Conditions ambiantes - UMGEBUNGSBEDINGUNGEN**

<b>Température</b>	TEMPERATUR	0 – 40 °C
<b>Humidité maximale</b>	MAXIMALE FEUCHTIGKEIT	95% <b>sans condensation</b> OHNE KONDENSWASSER
<b>Niveau de bruit</b>	GERÄUSCHGRAD	< 70 decibel

**B. Allacciamenti alimentazione elettrica, alimentazione gas e scarico fumi per un modulo di cottura e per la sovrapposizione di massimo tre moduli di cottura**

B. Connections for electrical and gas supply, exhaust for a single cooking unit and a maximum of three cooking units stacked one on top of another

B. Conexiones alimentación eléctrica, alimentación gas y descarga humos para un módulo de cocción y para la sobreposición máxima de tres módulos de cocción

**B. Branchements alimentation électrique, alimentation à gaz et évacuation des fumées pour un module de cuisson et pour la superposition de trois modules de cuisson maximum**

B. STROMANSCHLUß, GASANSCHLUß UND RAUCHGASABZUGANSCHLUß FÜR EIN BACKMODUL UND DAS ÜBEREINANDERLEGEN FÜR VON HÖCHSTENS DREI BACKMODULEN.

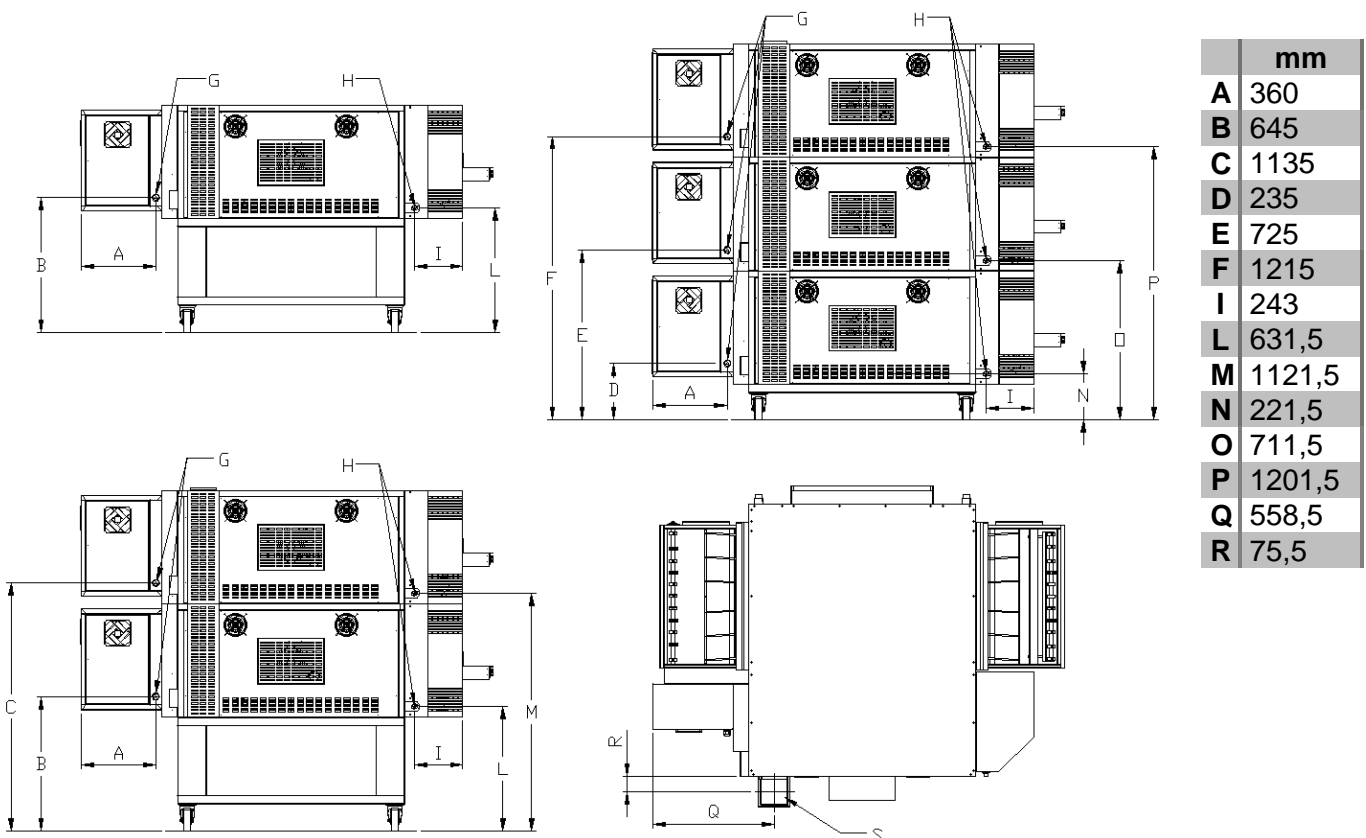

<b>G</b>	<b>Ingresso alimentazione elettrica</b>	Entry point for power supply	<i>Ingresso alimentación eléctrica</i>	<b>Entrée alimentation électrique</b>	EINGABE STROMSPEISUNG
<b>H</b>	<b>Ingresso alimentazione gas</b>	Entry point for gas	<i>Ingresso alimentación gas</i>	<b>Entrée alimentation gaz</b>	EINGABE GASSPEISUNG
<b>S</b>	<b>Scarico fumi combustione</b>	Combustion fumes exhaust	<i>Descarga humos combustión</i>	<b>Évacuation des fumées de combustion</b>	RAUCHGASABZUG

---

**C.1. Schema elettrico Synthesis 08/50 PW gas  
(230 Vac. ~ 1+N 50-60Hz)**

**C.2. Collegamento del motore in 60Hz**

C.1. Wiring diagram Synthesis 08/50 PW gas  
(230 Vac. ~ 1+N 50-60Hz)

C.2. Connection of motor in 60Hz

*C.1. Squema eléctrico Synthesis 08/50 PW gas  
(230 Vac. ~ 1+N 50-60Hz)*

*C.2. Conexión del motor en 60 Hz*

**C.1. Schéma électrique Synthesis 08/50 PW gas  
(230 Vac. ~ 1+N 50-60Hz)**

**C.2. Connexion du moteur à 60 Hz**

C.1. SCHALTPLAN SYNTHESIS 08/50 PW GAS  
(230 Vac. ~ 1+N 50-60Hz)

C.2. ANSCHLUSS DER MOTOR IN 60 HZ

# C.1.

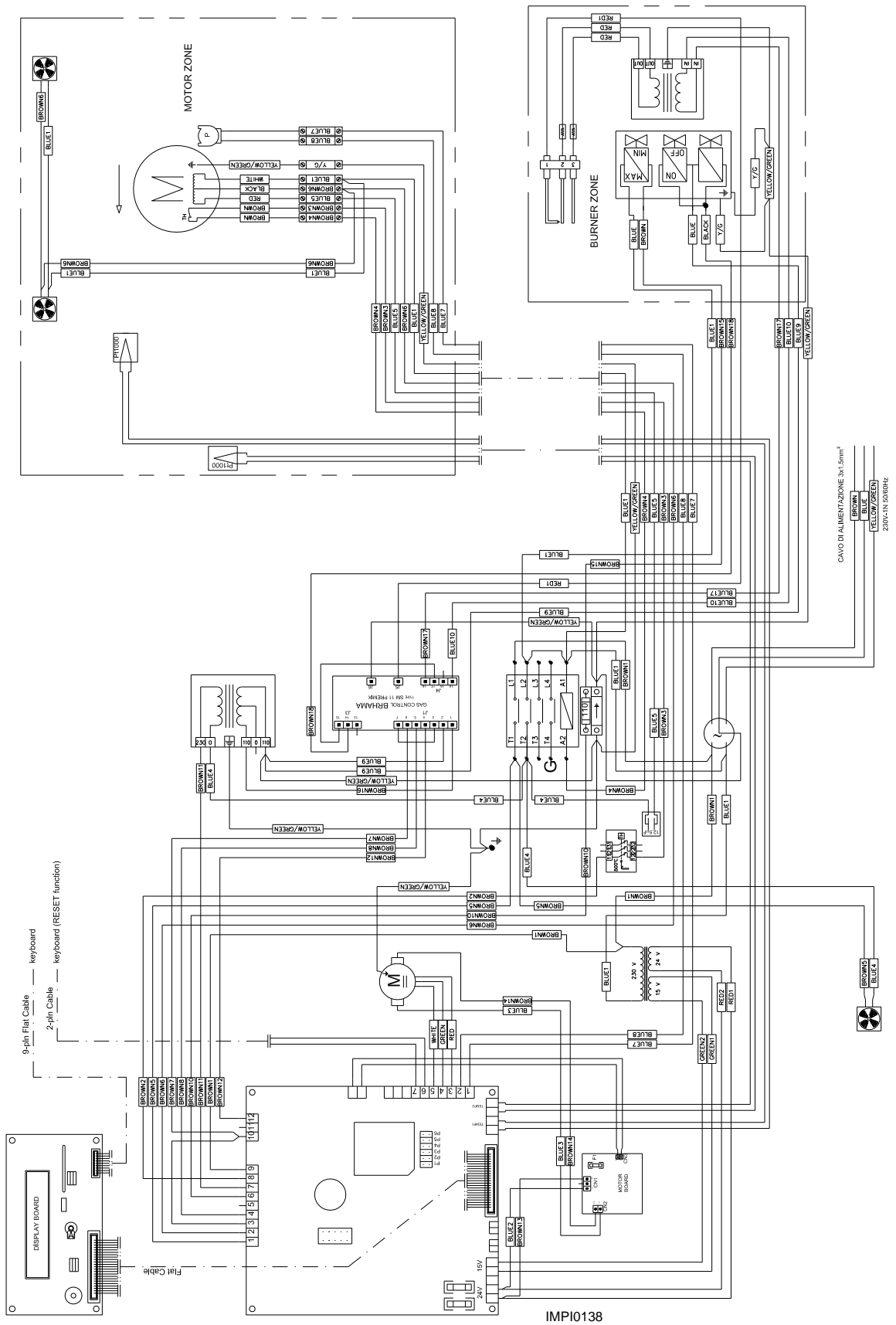

IMPI0138

## C.2.

IMP10138-2

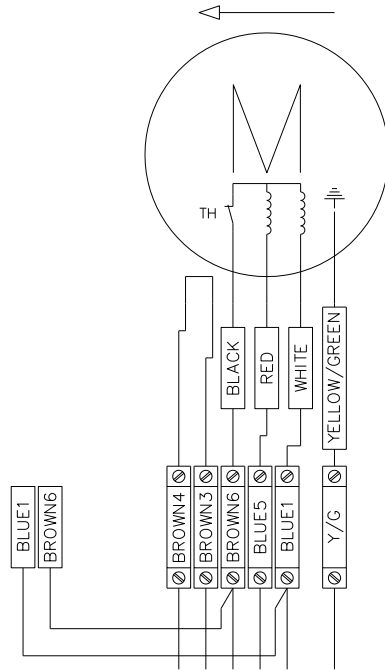

ZONA MOTORE/  
MOTOR ZONE

COLLEGAMENTO  
MOTORE 60Hz/  
CONNECTION  
MOTOR 60Hz

---

## **D. DISEGNI ESPLOSI ED ELENCO PARTI DI RICAMBIO**

**Per interventi complessi e nel caso di rotture vi preghiamo di contattarci. Comunque, allo scopo di semplificare la ricerca dei guasti e l'eventuale sostituzione delle parti danneggiate, diamo di seguito una lista delle parti di ricambio, i disegni esplosi e figure con i riferimenti a ciascuna delle parti elencate.**

## **D. EXPLODED VIEWS AND LIST OF SPARE PARTS**

For complicated maintenance works and in case of breakages we kindly ask you to contact us.

However, in order to simplify troubleshooting and possible replacement of damaged parts, we give below a list of spare parts, exploded drawings and figures with references to each party listed.

## ***D. DIBUJOS TÉCNICOS Y LISTA DE REPUESTOS***

*Para interventos más complicados y en caso de rupturas, les rogamos contactarnos. En todo caso, con el fin de simplificar la búsqueda de las averías y la eventual sustitución de piezas dañadas, damos a continuación una lista de repuestos, los dibujos técnicos y figuras referentes a cada una de las piezas elencadas.*

## ***D. Dessins d'ensemble et liste des pièces de rechange***

***Nous vous prions de nous contacter en cas d'interventions plus complexes ou de ruptures. Toutefois, afin de simplifier la recherche des avaries et l'éventuelle substitution de pièces endommagées, vous trouverez ci-dessous une liste des pièces de rechange, les dessins d'ensemble et les figures avec les références de toutes les pièces indiquées.***

## **D. EXPLOSIONSZEICHNUNGEN UND ERSATZTEILLISTE**

BITTE SETZEN SIE SICH BEI UMFANGREICHEREN EINGRIFFEN BZW. BEI BRÜCHEN MIT UNS IN VERBINDUNG. UM DIE STÖRUNGSSUCHE UND DAS AUSWECHSELN VON EVENTUELL BESCHÄDIGTEN TEILEN ZU ERLEICHTERN, FÜHREN WIR NACHSTEHEND EINE ERSATZTEILLISTE UND DIE EXPLOSIONSZEICHNUNGEN MIT DEN BEZÜGEN DER AUFGEFÜHRTE TEILE AUF.

## Tabella codici di riferimento componenti di carpenteria

List of spare component parts

*Tabla códigos de referencia componentes de carpintería*

	DESCRIZIONE	DESCRIPTION	DENOMINACIÓN	
1	<b>Telaio vetro esterno porta</b>	Door external glass frame	<i>Telar vidrio externo puerta</i>	CARP1869
2	<b>Maniglia porta</b>	Door handle	<i>Manilla puerta</i>	MANI0080
3	<b>Giunto supporto vetro esterno</b>	Coupling for external glass support	<i>Junta soporte vidrio externo</i>	CARP1870
4	<b>Molla sx</b>	Left door spring	<i>Resorte sx</i>	SPRI0009
5	<b>Boccola porta</b>	Door bush	<i>Buje puerta</i>	BOCC0006
6	<b>Telaio portina</b>	Door frame	<i>Telar puerta</i>	PORT0292
7	<b>Porta interna</b>	Internal door	<i>Puerta interior</i>	PORT0293
8	<b>Staffa porta sx</b>	Left staff	<i>Abrazadera puerta sx</i>	SUPP0206
9	<b>Diffusore superiore dx / inferiore sx</b>	Upper diffuser dx / Lower sx	<i>Difusor superior dx / inferior sx</i>	CARP1439
10	<b>Diffusore inferiore dx / superiore sx</b>	Lower diffuser dx / Upper sx	<i>Difusor inferior dx / superior sx</i>	CARP1440
11	<b>Paratoia</b>	Cofferdam	<i>Compuerta</i>	CARP1433
12	<b>Cielo forno</b>	Oven top	<i>Cielo horno</i>	FIAN0317
13	<b>Pannello carter bruciatore</b>	Panel burner housing	<i>Tapa cárter quemador</i>	PANN0205
14	<b>Carter bruciatore</b>	Carter burner	<i>Cárter quemador</i>	CART0185
15	<b>Camera combustione</b>	Combustion chamber	<i>Cámara combustión</i>	CARP1438
16	<b>Ventola primaria</b>	Fan primary	<i>Ventilador primario</i>	VENT0018
17	<b>Pannello posteriore</b>	Rear Panel	<i>Panel posterior</i>	FIAN0455
18	<b>Carter motore ventilazione superiore</b>	Upper ventilation motor casing	<i>Cárter motor ventilación superior</i>	FIAN0456
19	<b>Carter motore ventilazione inferiore</b>	Lower ventilation motor casing	<i>Cárter motor ventilación inferior</i>	FIAN0457
20	<b>Protezione camino</b>	Fire protection	<i>Protección chimenea</i>	CARP1434
21	<b>Camino</b>	Fireplace	<i>Chimenea</i>	TUBO0135
22	<b>Cielo carter comandi</b>	Sky carter commands	<i>Cielo cárter comandos</i>	CART0131
23	<b>Pannello chiusura carter comandi</b>	Command Panel carter	<i>Panel cierre cárter comandos</i>	CART0134
24	<b>Fascia carter comandi</b>	Carter commands	<i>Banda cárter comandos</i>	CART0130
25	<b>Base carter comandi</b>	Base carter commands	<i>Base cárter comandos</i>	CART0132
26	<b>Bancale rete</b>	Pallet Conveyor	<i>Bancada red</i>	CARP1427
27	<b>Fermo registrabile</b>	Stop Recording	<i>Afianzador registrable</i>	CARP1443
28	<b>Teglia telaio rete uscita</b>	Baking tin frame conveyor exit	<i>Bandeja telar red salida</i>	CARP1431
29	<b>Teglia telaio rete ingresso</b>	Baking tin frame conveyor input	<i>Bandeja telar red ingreso</i>	CARP1432
30	<b>Protezione giunto rete</b>	Coverjoint	<i>Protección junta red</i>	CARP1437
31	<b>Staffa porta dx</b>	Right staff	<i>Abrazadera puerta dx</i>	SUPP0207
32	<b>Cristallo porta</b>	Glass door	<i>Cristal puerta</i>	CRIS0026
33	<b>Molla dx</b>	Right door spring	<i>Resorte dx</i>	SPRI0010
34	<b>Ferma vetro porta</b>	Door holder	<i>Tope vidrio puerta</i>	CARP0545
35	<b>Porta esterna</b>	External door	<i>Puerta externa</i>	PORT0294
36	<b>Copri molla porta</b>	Door spring cover	<i>Protección resorte puerta</i>	CARP1442
37	<b>Rondella gomma vetro esterno</b>	Rubber washer for external glass	<i>Arandela goma vidrio externo</i>	GUAR0051
38	<b>Vetro esterno porta</b>	Door external glass	<i>Vidrio externo puerta</i>	CRIS0076



39	<b>Vite supporto vetro esterno</b>	Screw for external glass support	<i>Tornillo soporte vidrio externo</i>	CARP1871
40	<b>Boccola albero folle</b>	Bush	<i>Buje árbol vacío</i>	BOCC0013
41	<b>Perno albero folle</b>	Idle shaft	<i>Árbol vacío interior</i>	MECC0467
42	<b>Tubo tendi rete</b>	Tube tend Conveyor	<i>Árbol vacío exterior</i>	MECC0472
43	<b>Distanziale rete</b>	Spacer Conveyor	<i>Distanciador red</i>	MECC0036
44	<b>Ruota rete</b>	Rotate Conveyor	<i>Rueda red</i>	MECC0035
45	<b>Rete</b>	Conveyor	<i>Red</i>	RETE0013
46	<b>Cuscinetto rete</b>	Conveyor bearing	<i>Cojinete red</i>	CUSC0022
47	<b>Albero traino rete</b>	Conveyor driving shaft	<i>Árbol arrastre red</i>	MECC0571
48	<b>Giunto traino rete</b>	Conveyor Joint hub	<i>Junta arrastre red</i>	MECC0114

**Table codes de référence composants de charpenterie**

**METALLBESTANDTEILE - KODENTABELLE**

	<b>DÉSIGNATION</b>	<b>BESCHREIBUNG</b>	
1	<b>Structure vitre externe porte</b>	AUßENGLASRAHMEN TÜR	CARP1869
2	<b>Poignée porte</b>	TÜRGRIF	MANI0080
3	<b>Joint support vitre externe</b>	VERBINDUNGSSTÜCK AUßENGLASSCHEIBE	CARP1870
4	<b>Ressort gauche</b>	LINKE FEDER	SPRI0009
5	<b>Raccord porte</b>	TÜRBÜCHSE	BOCC0006
6	<b>Structure porte</b>	TÜRRAHMEN	PORT0292
7	<b>Porte interne</b>	TÜRINNENSEITE	PORT0293
8	<b>Etrier porte gauche</b>	LINKER TÜRHALTER	SUPP0206
9	<b>Diffuseur sup. droit / inf. gauche</b>	VERTEILER OBEN RECHTS / UNTEN LINKS	CARP1439
10	<b>Diffuseur inf. droit / sup. gauche</b>	VERTEILER UNTEN RECHTS / OBEN LINKS	CARP1440
11	<b>Vanne</b>	PLATTE	CARP1433
12	<b>Voûte four</b>	OFENDECKE	FIAN0317
13	<b>Fermeture carter brûleur</b>	DECKE BRENNERSCHUTZVORRICHTUNG	PANN0205
14	<b>Carter brûleur</b>	BRENNERSCHUTZVORRICHTUNG	CART0185
15	<b>Chambre de combustion</b>	BRENNKAMMER	CARP1438
16	<b>Ventilateur primaire</b>	HAUPTVENTILATOR	VENT0018
17	<b>Panneau postérieur</b>	HINTERE PLATTE	FIAN0455
18	<b>Carter moteur ventilation supérieur</b>	MOTORABDECKUNG OBERES GEBLÄSES	FIAN0456
19	<b>Carter moteur ventilation inférieur</b>	MOTORABDECKUNG UNTERES GEBLÄSES	FIAN0457
20	<b>Protection cheminée</b>	SCHORNSTEINSCHUTZVORRICHTUNG	CARP1434
21	<b>Cheminée</b>	SCHORNSTEIN	TUBO0135
22	<b>Voûte carter des commandes</b>	DECKEL ABDECKUNG SCHALTUNGSVORRICHTUNG	CART0131
23	<b>Panneau fermeture carter commandes</b>	ABDECKUNGSPLATTE SCHALTUNGSVORRICHTUNG	CART0134
24	<b>Partie carter des commandes</b>	ABDECKUNGSPLATTE SCHALTUNGSVORRICHTUNG	CART0130
25	<b>Base carter des commandes</b>	GRUNDPLATTE ABDECKUNG SCHALTUNGSVORRICHTUNG	CART0132
26	<b>Support ruban transporteur</b>	NETZBANDRAHMEN	CARP1427
27	<b>Butée réglable</b>	EINSTELLBARER HALTER	CARP1443
28	<b>Plat structure ruban transp. sortie</b>	BACKBLECH NETZBANDRAHMEN - AUSLAUF	CARP1431
29	<b>Plat structure ruban transp. Entrée</b>	BACKBLECH NETZBANDRAHMEN - EINLAUF	CARP1432
30	<b>Protection joint réseau</b>	SCHUTZABDECKUNG NETZBANDKUPPLUNG	CARP1437
31	<b>Etrier porte droite</b>	RECHTER TÜRHALTER	SUPP0207
32	<b>Verre porte</b>	TÜRGLAS	CRIS0026
33	<b>Ressort droit</b>	RECHTE FEDER	SPRI0010
34	<b>Parclose porte</b>	GLASHALTER TÜR	CARP0545
35	<b>Porte externe</b>	AUßENTÜR	PORT0294
36	<b>Couvre ressort porte</b>	TÜRFEDERABDECKUNG	CARP1442
37	<b>Rondelle en caoutchouc vitre externe</b>	GUMMIUNTERLEGSscheibe AUßENGLAS	GUAR0051
38	<b>Vitre externe porte</b>	AUßENGLAS TÜR	CRIS0076
39	<b>Vis support vitre externe</b>	STÜTZSCHRAUBE AUßENGLAS	CARP1871
40	<b>fourreau pignon fou</b>	BUCHSE LEERLAUFWELLE	BOCC0013
41	<b>Pignon fou interne</b>	INNERE LEERLAUFWELLE	MECC0467
42	<b>Pignon fou externe</b>	ÄUßERE LEERLAUFWELLE	MECC0472
43	<b>Entretoise ruban transporteur</b>	DISTANZSTÜCK NETZBAND	MECC0036
44	<b>Roue ruban transporteur</b>	NETZBANDRAD	MECC0035
45	<b>Ruban transporteur</b>	NETZBAND	RETE0013
46	<b>Coussinet ruban transporteur</b>	LAGER NETZBAND	CUSC0022
47	<b>Arbre tendeur du ruban transporteur</b>	ANTRIEBSWELLE	MECC0571
48	<b>Joint de traction ruban transporteur</b>	NETZBANDANTRIEBSKUPPLUNG	MECC0114

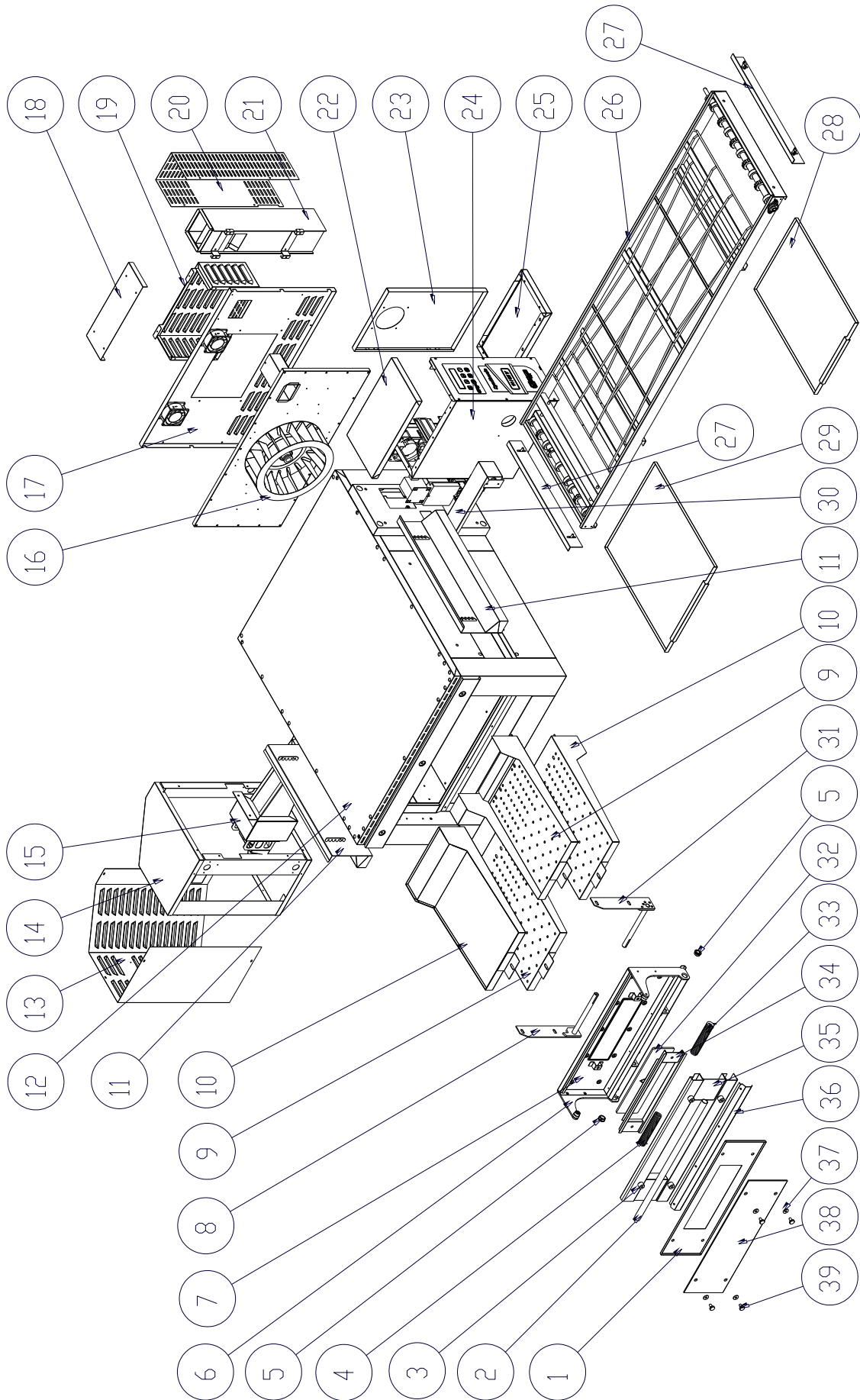

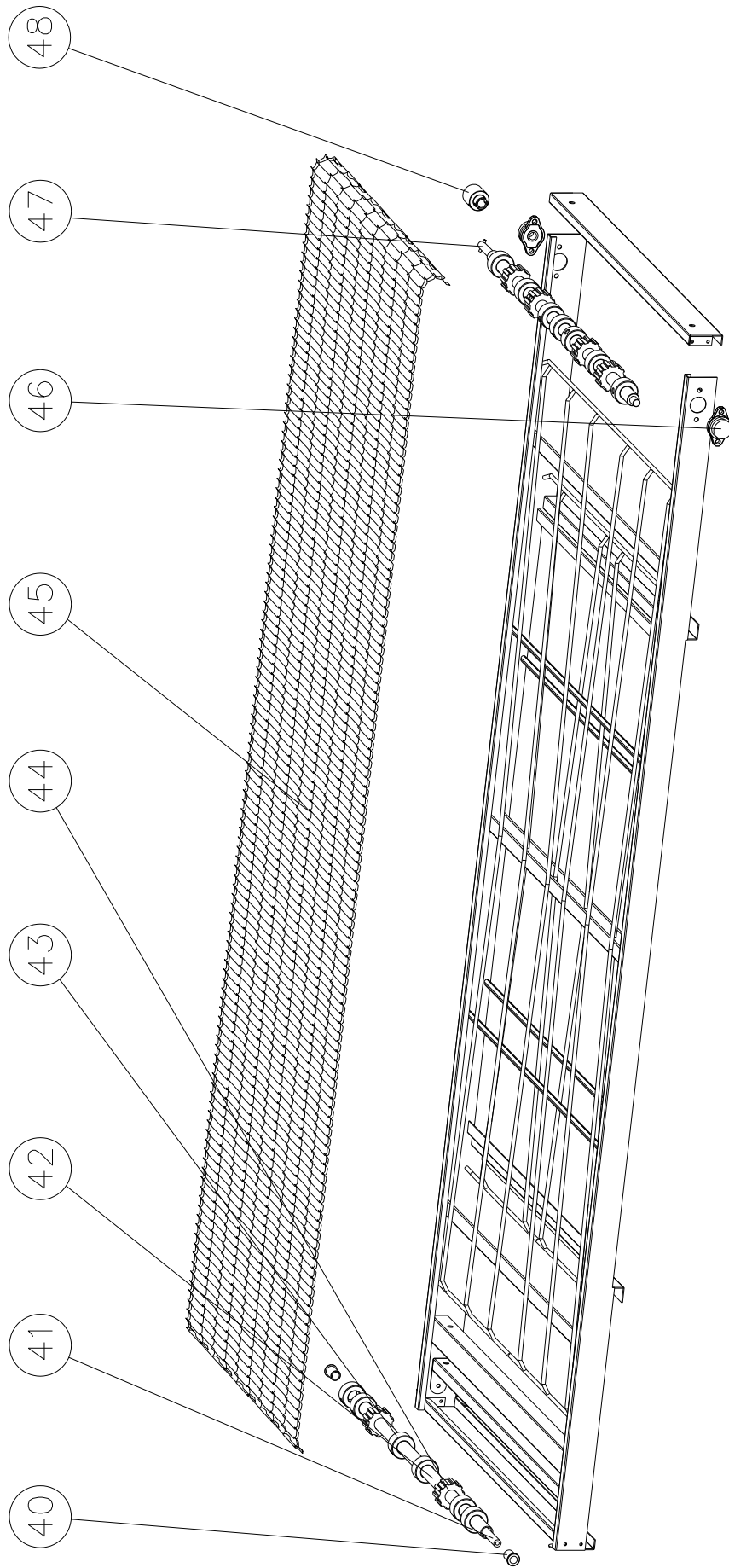

**Tabella codici di riferimento componenti elettrici**  
 List of electrical components parts  
*Tabla códigos de referencia componentes eléctricos*

	DESCRIZIONE	DESCRIPTION	DENOMINACIÓN	
1	Scheda display	Display Card	Cédula display	ELET0673
2	Motore rete (Transtecno) Motore rete (Automec)	Conveyor motor (Transtecno) Conveyor motor (Automec)	Motor red (Transtecno) Motor red (Automec)	MOTO0052 MOTO0004
3	Scheda base	Base board	Cédula base	ELET0676
4	Trasformatore toroidale per scheda base	Toroidal Transformer for Display Card	Trasformador toroidal para cédula base	ELET0156
5	Scheda elettronica rete	Electronic board Conveyor	Cédula electrónica red	ELET0213
6	Trasformatore di isolamento	Transformer	Trasformador de aislamiento	ELET0003
7	Centralina accensione gas	Flame control	Centralina encendido gas	ELET0134
8	Teleruttore 20A	Contactora 20A	Telerruptor 20A	ELET0480
9	Morsetto portafusibile 4 mm <sup>2</sup>	Fuse terminal 4 mm <sup>2</sup>	Borne portafusibile 4 mm <sup>2</sup>	ELET0722
10	Fusibile	Fuse	Fusible	ELET0204
11	Morsetto di terra 10 mm <sup>2</sup>	Earth terminal 10 mm <sup>2</sup>	Borne de tierra 10 mm <sup>2</sup>	ELET0720
12	Condensatore motore vent.	Condenser fan motor	Condensa motor vent.	ELET0350
13	Soppressore disturbi	Noise suppressor	Supresor disturbios	ELET0142
14	Termostato di sicurezza	Safety Thermostat	Termostato de seguridad	TERM0005
15	Sonda PT1000	Thermocouple PT1000	Sonda PT1000	TERM0049
16	Ventola raffreddamento	Fan cooling	Ventilador enfriamiento	VENT0012
17	Griglia protezione ventola raff.	Grid Security fan cooling	Reja protección vent.enfriam	VENT0025
18	Ventola raffreddamento	Fan cooling	Ventilador enfriamiento	VENT0024
19	Motore ventilazione (50Hz) Motore ventilazione (60Hz)	Fan motor (50 Hz) Fan motor (60 Hz)	Motor ventilación (50Hz) Motor ventilación (60Hz)	MOTO0030 MOTO0076
20	Pressostato + Supporto Pressostato (Honeywell)	Thrust meter + Holder Thrust meter	Presostato + Soporte Presostato (Honeywell)	ELET0641 + SUPP0414 ELET0130
21	Pulsantiera	Push button	Botonera	ELET0656
22	Pannello serigrafato	Serigraph Panel	Panel serigrafiado	PANN0468
23	Filtro ventola raffreddamento	Filter fan cooling	Filtro ventil. enfriamiento	FLTR0003

*Tableau des codes de référence composants électriques*  
TABELLE BEZUGSARTIKELNUMMERN ELEKTRISCHEN KOMPONENTE

	<b>DÉSIGNATION</b>	<b>BESCHREIBUNG</b>	
1	<b>Carte display</b>	DISPLAYKARTE	ELET0673
2	<b>Moteur ruban transporteur (Transtecno)</b> <b>Moteur ruban transporteur (Automec)</b>	NETZBANDMOTOR (TRANSTECNO) NETZBANDMOTOR (AUTOMECC)	MOTO0052 MOTO0004
3	<b>Carte base</b>	GRUNDELEKTRONIKKARTE	ELET0676
4	<b>Transformateur toroïdal pour carte base</b>	RINGKERNTRANSFORMATOR FÜR BASISKARTE	ELET0156
5	<b>Carte électronique ruban tranp</b>	ELEKTRONIKKARTE NETZBAND	ELET0213
6	<b>Transformateur d'isolement</b>	ISOLIERUNGSTRANFORMATOR	ELET0003
7	<b>Centrale allumage gaz</b>	STEUERUNG GASZÜNDUNG	ELET0134
8	<b>Térlrupteur 20A</b>	FERNSCHALTER 20A	ELET0480
9	<b>Borne porte fusible 4 mm<sup>2</sup></b>	KLEMME SICHERUNGSHALTER 4 MM <sup>2</sup>	ELET0722
10	<b>Fusible</b>	SICHERUNG	ELET0204
11	<b>Borne de terre 10 mm<sup>2</sup></b>	ERDEKLEMME 10 MM <sup>2</sup>	ELET0720
12	<b>Condensateur moteur vent.</b>	KONDENSATOR VENTILATORMOTOR	ELET0350
13	<b>Filtre antiparasite</b>	STÖRUNGSDÄMPER	ELET0142
14	<b>Thermostat de sécurité</b>	SICHERHEITSTHERMOSTAT	TERM0005
15	<b>Sonde PT1000</b>	SONDE PT1000	TERM0049
16	<b>Hélice de refroidissement</b>	KÜHLVENTILATOR	VENT0012
17	<b>Grille protection hélice de refroidissement</b>	SCHUTZGITTER KÜHLVENTILATOR	VENT0025
18	<b>Hélice de refroidissement</b>	KÜHLVENTILATOR	VENT0024
19	<b>Moteur ventilation (50 Hz)</b> <b>Moteur ventilation (60 Hz)</b>	VENTILATORMOTOR (50 Hz) VENTILATORMOTOR (60 Hz)	MOTO0030 MOTO0076
20	<b>Pressostat + Support</b> <b>Pressostat (Honeywell)</b>	DRUCKSCHALTER + STÄNDER DRUCKSCHALTER (HONEYWELL)	ELET0641 + SUPP0414  ELET0130
21	<b>Tableau</b>	DRUCKTASTENTAFEL	ELET0656
22	<b>Panneau sérigraphé</b>	SIEBBEDRUCKTE TAFEL	PANN0468
23	<b>Filtre hélice de refroidissement</b>	FILTER KÜHLVENTILATOR	FLTR0003



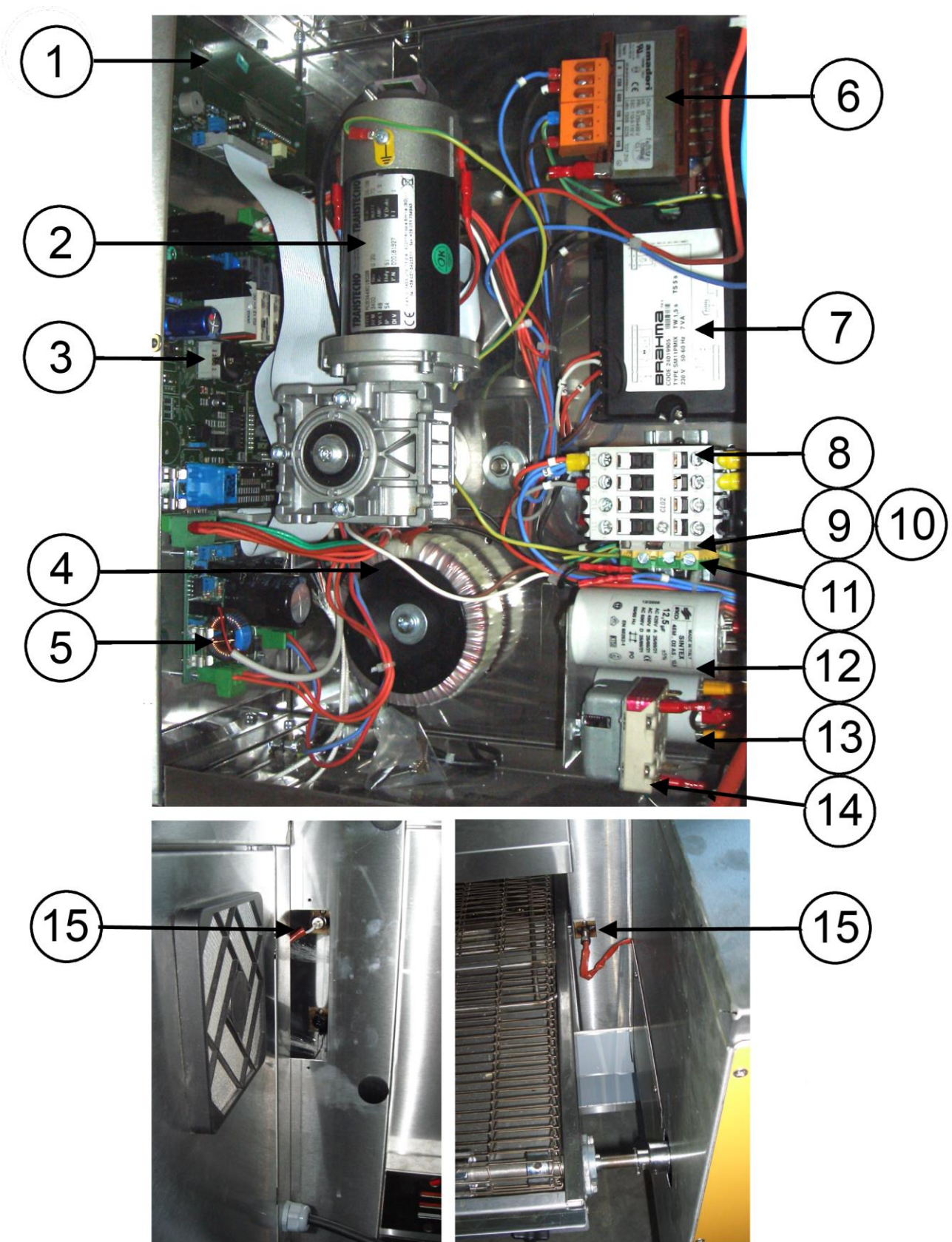

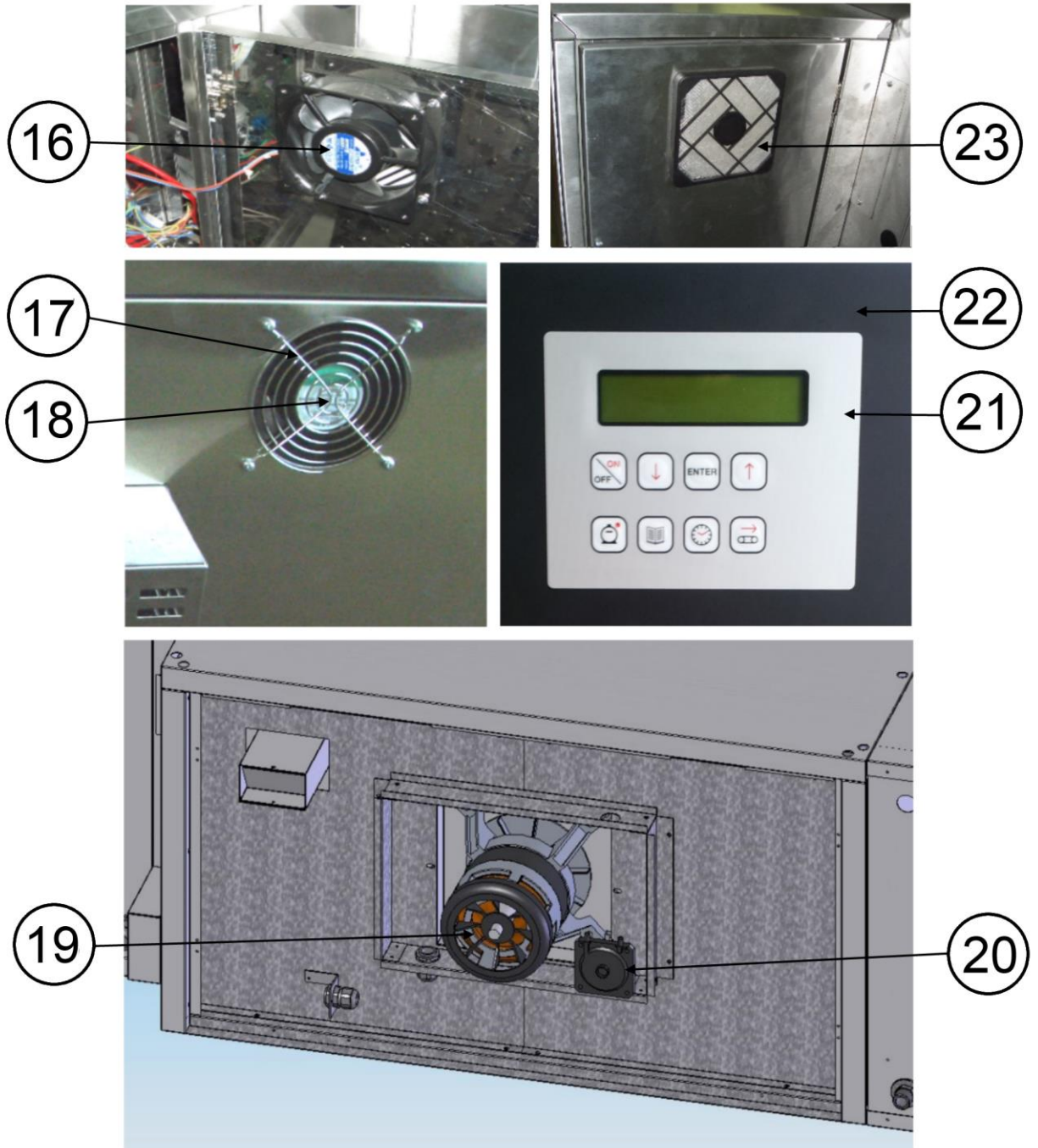



**Tabella codici di riferimento gruppo bruciatore**  
 List of group burners components parts  
*Tabla códigos de referencia componentes grupo quemador*

	<b>DESCRIZIONE</b>	<b>DESCRIPTION</b>	<b>DENOMINACIÓN</b>	
1	<b>Trasformatore per centralina gas</b>	Transformer for gas unit	<i>Trasformador para centralina gas</i>	ELET0135
2	<b>Cavo elettrodo rilevazione fiamma (1)</b>	Wire for ignition electrode (1)	<i>Cable electrodo relevación llama (1)</i>	CAVI0059
3	<b>Elettrodo rilevazione fiamma (1)</b>	Ignition electrode (1)	<i>Electrodo relevación llama (1)</i>	ELET0410
4	<b>Supporto bruciatore</b>	Nozzle pipe support	<i>Soporte quemador</i>	BGAS0038
5	<b>Elettrodo accensione fiamma (3)</b>	Flame electrode (3)	<i>Electrodo encendido llama(3)</i>	ELET0412
6	<b>Elettrodo accensione fiamma (2)</b>	Flame electrode (2)	<i>Electrodo encendido llama (2)</i>	ELET0411
7	<b>Cavo elettrodo accensione fiamma</b>	Wire for flame electrode	<i>Cable electrodo encendido llama</i>	CAVI0057
8	<b>Torcia completa METANO - GPL</b>	Complete nozzle pipe METHANE - GPL	<i>Antorcha completa METANO - GPL</i>	CARP0357
9a	<b>Connettore bobina modulante per elettrovalvola (50Hz)</b>	Modulating coil connector for solenoid valve (50 Hz)	<i>Conectador para bobina moduladora de electroválvula (50 Hz)</i>	ELET0483
9b	<b>Connettore bobina modulante per elettrovalvola (60Hz)</b>	Modulating coil connector for solenoid valve (60Hz)	<i>Conectador para bobina moduladora de electroválvula (60 Hz)</i>	ELET0483
10a	<b>Connettore bobina per elettrovalvola (50Hz)</b>	Coil connector for solenoid valve (50Hz)	<i>Conectador para bobina de electroválvula (50Hz)</i>	ELET0478
10b	<b>Connettore bobina per elettrovalvola (60Hz)</b>	Coil connector for solenoid valve (60Hz)	<i>Conectador para bobina de electroválvula (60Hz)</i>	ELET0478
11a	<b>Elettrovalvola (50Hz)</b>	Gas valve (50 Hz)	<i>Electroválvula (50 Hz)</i>	GASI0060
11b	<b>Elettrovalvola (60Hz)</b>	Gas valve (60 Hz)	<i>Electroválvula (60 Hz)</i>	GASI0104

**Tableau des codes de référence composants groupe brûleur**  
**Brenner - Kodentabelle**

	<b>DÉSIGNATION</b>	<b>BESCHREIBUNG</b>	
<b>1</b>	<b><i>Transformateur pour centrale gaz</i></b>	TRANSFORMATOR GASSTEUERVORRICHTUNG	ELET0135
<b>2</b>	<b><i>Câble électrode détection flamme (1)</i></b>	KABEL ELEKTRODE FLAMMENDETEKTION (1)	CAVI0059
<b>3</b>	<b><i>Électrode détection de la flamme (1)</i></b>	ELEKTRODE FLAMMENZÜNDUNG (1)	ELET0410
<b>4</b>	<b><i>Support brûleur</i></b>	BRENNERHALTER	BGAS0038
<b>5</b>	<b><i>Électrode allumage de la flamme (3)</i></b>	ELEKTRODE FLAMMENZÜNDUNG (3)	ELET0412
<b>6</b>	<b><i>Électrode allumage de la flamme (2)</i></b>	ELEKTRODE FLAMMENZÜNDUNG (2)	ELET0411
<b>7</b>	<b><i>Câble électrode allumage flamme</i></b>	KABEL ELEKTRODE FLAMMENZÜNDUNG	CAVI0057
<b>8</b>	<b><i>Torche complète MÉTHANE - GPL</i></b>	KOMPLETTE FACKEL METHANGAS- LPG	CARP0357
<b>9a</b>	<b><i>Connecteur bobine de modulation pour électrovanne (50 Hz)</i></b>	VERBINDER FÜR MODULATIONSSPULE DES GASVENTILS (50 Hz)	ELET0483
<b>9b</b>	<b><i>Connecteur bobine de modulation pour électrovanne (60 Hz)</i></b>	VERBINDER FÜR MODULATIONSSPULE DES GASVENTILS (60 Hz)	ELET0483
<b>10a</b>	<b><i>Connecteur bobine pour électrovanne (50 Hz)</i></b>	VERBINDER FÜR GASVENTILSSPULE (50 Hz)	ELET0478
<b>10b</b>	<b><i>Connecteur bobine pour électrovanne (60 Hz)</i></b>	VERBINDER FÜR GASVENTILSSPULE (60 Hz)	ELET0478
<b>11a</b>	<b><i>Électrovalve (50 Hz)</i></b>	ELEKTROVENTIL (50 Hz)	GASI0060
<b>11b</b>	<b><i>Électrovalve (60 Hz)</i></b>	ELEKTROVENTIL (60 Hz)	GASI0104

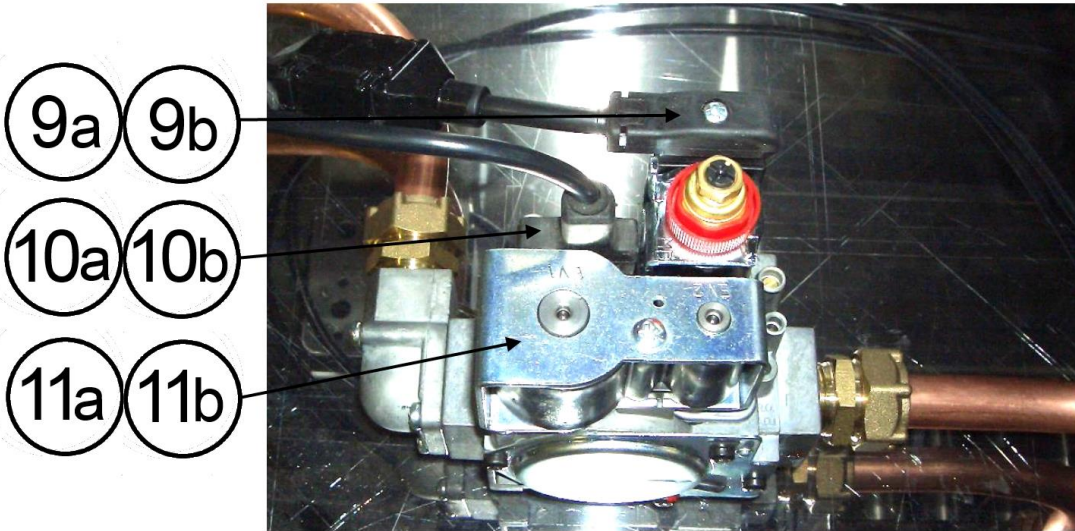
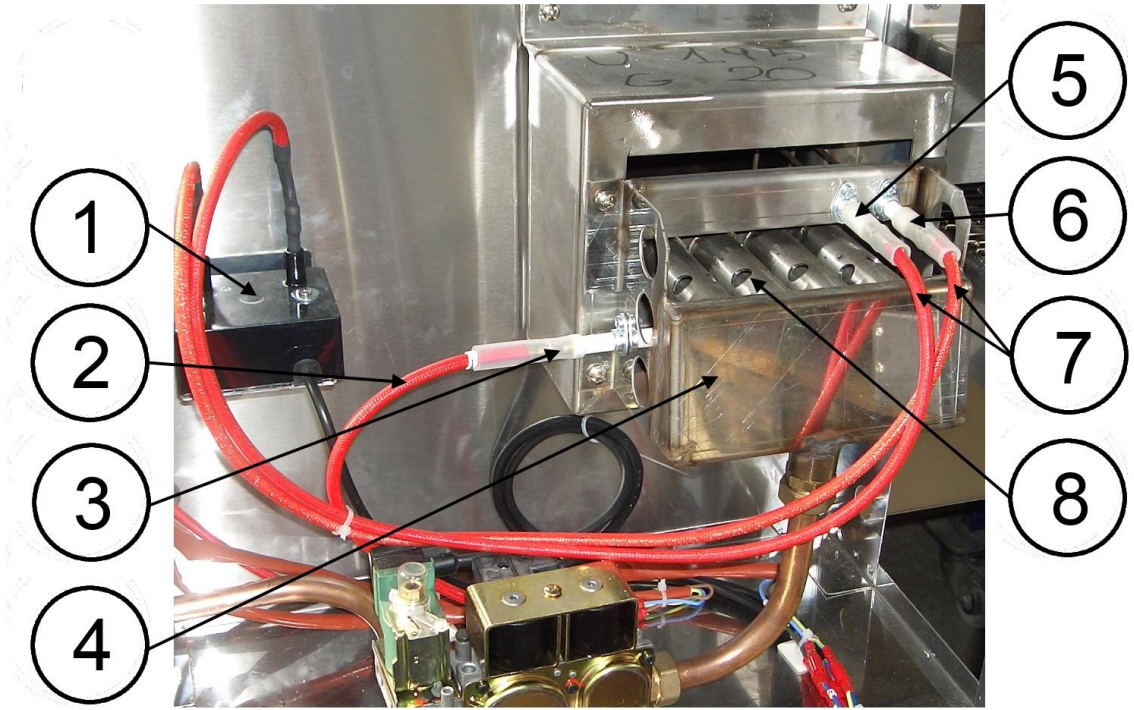



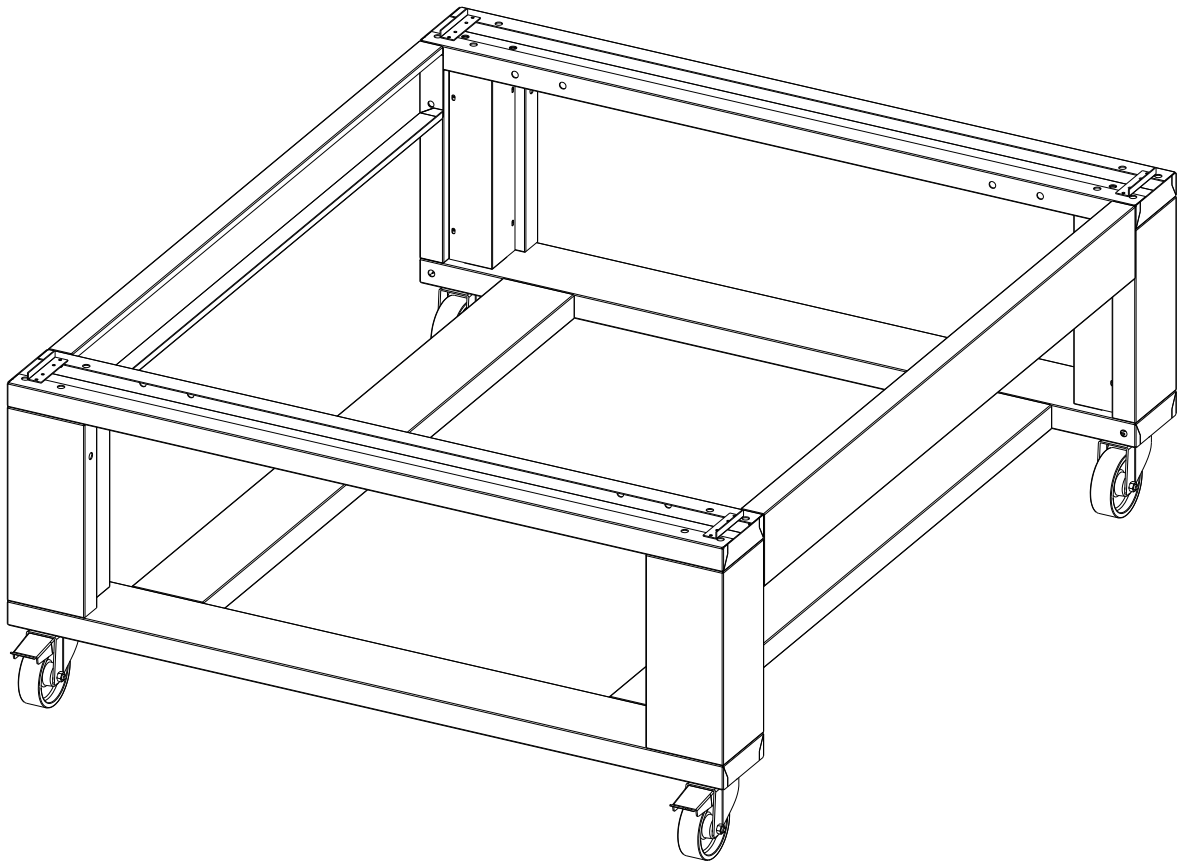

## **SYNTHESIS / BM**

**Manuale di installazione, uso e manutenzione**  
**Manual for installation, use and maintenance**  
***Manual de instalación, uso y manutención***  
***Notice d'installation, d'utilisation et d'entretien***  
**INSTALLATIONS-, BEDIENUNGS- UND INSTANDHALTUNGSHANDBUCH**

---

## 1. IDENTIFICAZIONE DEL PRODOTTO

Questo manuale si riferisce ai basamenti dei forni serie Synthesis modelli: 06/40, 08/50, 11/65, 12/80, 12/100.

I basamenti dei forni sopra citati sono stati progettati per il supporto dei moduli di cottura.

## 1. IDENTIFYING THE PRODUCT

This manual refers to bases for the ovens 06/40, 08/50, 11/65, 12/80, 12/100 models in the Synthesis series.

The bases for ovens mentioned above have been designed to support cooking units.

## 1. IDENTIFICACIÓN DEL PRODUCTO

*Este manual se refiere a las bases de los hornos serie Synthesis modelos: 06/40, 08/50, 11/65, 12/80, 12/100.*

*Las bases de los hornos previamente citados han sido proyectados como soportes de los módulos de cocción.*

## 1. IDENTIFICATION DU PRODUIT

***Ce manuel se réfère aux bases des fours série SYNTHESIS modèles : 06/40, 08/50, 11/65, 12/80, 12/100.***

***Les bases des fours indiqués ci-dessus ont été projetées pour le support des modules de cuisson.***

## 1. IDENTIFIZIERUNG DES PRODUKTES

DIESE BEDIENUNGSANLEITUNG BEZIEHT SICH AUF DIE BACKÖFEN BAUREIHE SYNTHESIS MODELLE: 06/40, 08/50, 11/65, 12/80, 12/100.

DIE UNTERGESTELLE DER OBEN GENANNTEN BACKÖFEN WURDEN ZUR UNTERSTÜTZUNG DER BACKMODULE GEPLANT.

---

## 2. ISTRUZIONI DI MONTAGGIO

I basamenti vengono consegnati smontati e forniti con kit bulloneria necessario al montaggio, nelle due configurazioni previste (vedi disegni esplosi):

- A) basamento per n°1 o 2 moduli di cottura sovrapposti
- B) basamento per n°3 moduli di cottura sovrapposti.

Diamo di seguito i disegni esplosi e una lista delle parti che compongono i basamenti, con riferimenti a ciascuna delle parti elencate.

## 2. ASSEMBLY INSTRUCTIONS

Bases are consigned disassembled together with a kit of bolts for assembling the base in two different configurations:

- A) base for one or two cooking units stacked one on top of the other
- B) base for three cooking modules stacked one on top of the other.

An exploded diagram of the base is shown below referring to each part in the part lists that follow.

## 2. INSTRUCCIONES DE MONTAJE

*Las bases se entregan desmontadas y con un kit tuercas necesario para el montaje, en las dos configuraciones previstas (ver dibujo técnico):*

- A) base para n°1 ó 2 módulos de cocción sobrepuestos*
- B) base para n°3 módulos de cocción sobrepuestos.*

*A continuación, damos los dibujos técnicos y una lista de las piezas que componen las bases, con referencia a cada una de las mismas elencadas.*

## 2. INSTRUCTIONS POUR LE MONTAGE

*Les bases sont fournies démontées et avec un kit de boulons nécessaire au montage, pour les deux configurations prévues (voir dessin explosé):*

- A) base pour n°1 ou 2 modules de cuisson superposés*
- B) base pour n°3 modules de cuisson superposés.*

*Vous trouverez ci-dessous les dessins éclatés et une liste des pièces qui composent les bases, avec la référence de chaque pièce de la liste.*

## 2. INSTALLATIONSHINWEISE

DIE UNTERGESTELLE WERDEN ABMONTIERT GELIEFERT UND MIT EINEM BOLZENKIT FÜR MONTAGE IN DEN ZWEI FOLGENDEN AUSSTATTUNGEN BESCHAFFEN:

- C) UNTERGESTELL FÜR 1 ODER 2 ÜBEREINANDERLIEGENDE BACKMODULE
- D) UNTERGESTELL FÜR 3 ÜBEREINANDERLIEGENDE BACKMODULE

HIERUNTER SIND DIE EXPLOSIONSZEICHNUNGEN UND EINE LISTE DER KOMPONENTE DER UNTERGESTELLE MIT DEN BEZÜGEN DER AUFGEFÜHRTE TEILE.

**A.**

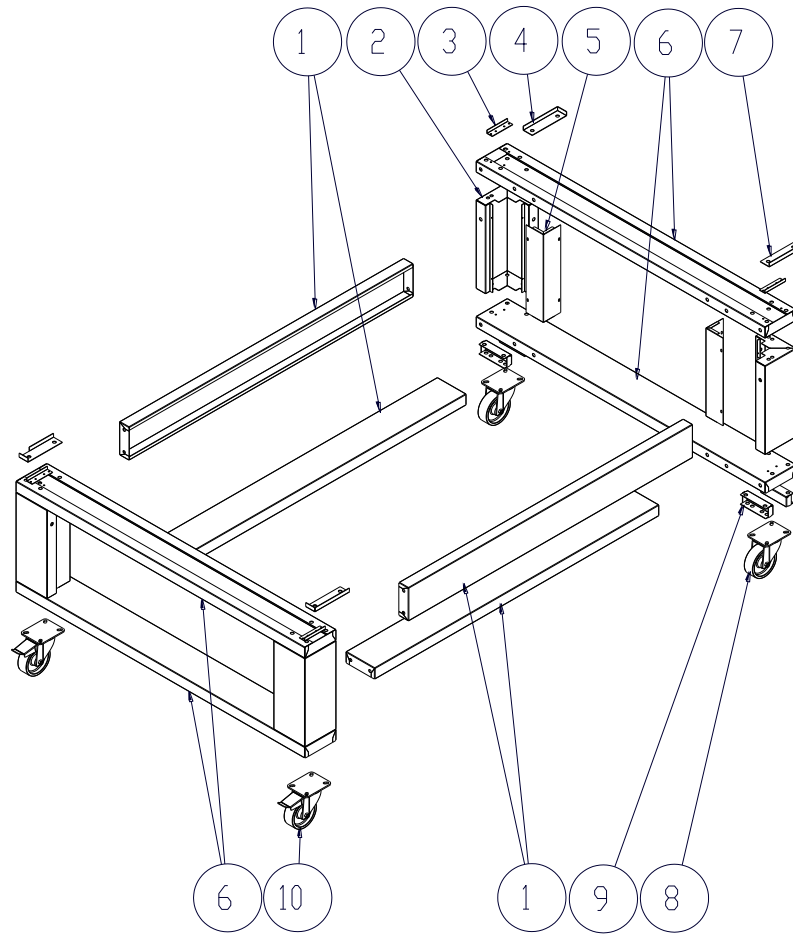

**B.**

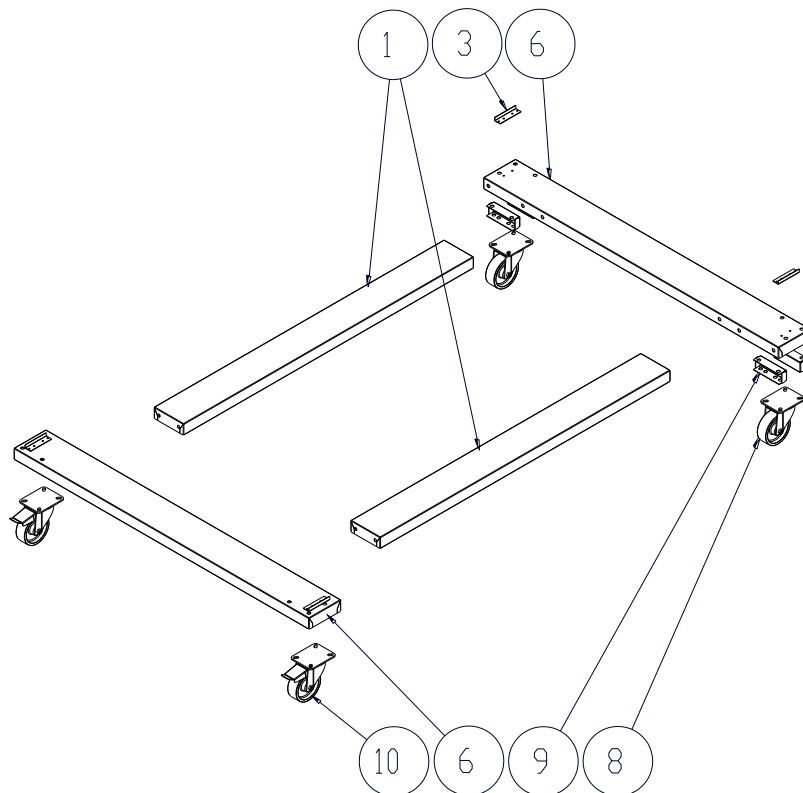



	Traverse Crosspieces Travesaños Traverses TRAVERSE		②+⑤ Gambe+carter Legs+cover Pies+carter Jambes STÜTZBEIN		
	⑥ FRONT	① LAT	1 MC	2 MC	3 MC
<b>SYNTHESIS 06/40 EL</b>	TRAV0220	TRAV0221	TRAV0223 CART0266	TRAV0223 CART0266	TRAV0224 CART0267
<b>SYNTHESIS 06/40 GAS</b>	TRAV0220	TRAV0222	TRAV0223 CART0266	TRAV0223 CART0266	TRAV0224 CART0267
<b>SYNTHESIS 08/50</b>	TRAV0167	TRAV0166	TRAV0195 CART0218	TRAV0195 CART0218	---
<b>SYNTHESIS 11/65</b>	TRAV0173	TRAV0171	TRAV0174 CART0210	TRAV0174 CART0210	---
<b>SYNTHESIS 12/80</b>	TRAV0215	TRAV0216	TRAV0217 CART0252	TRAV0217 CART0252	---
<b>SYNTHESIS 12/100 EL</b>	TRAV0156	TRAV0157	TRAV0159 CART0179	TRAV0159 CART0179	TRAV0208 CART0236
<b>SYNTHESIS 12/100 GAS</b>	TRAV0156	TRAV0158	TRAV0159 CART0179	TRAV0159 CART0179	TRAV0208 CART0236

	Staffa fissaggio Fixing spar Abrazadera sujección Etrier de fixation BEFESTIGUNGSHALTER		
	③	④	⑦
<b>SYNTHESIS 06/40 EL</b>	CARP1522	---	---
<b>SYNTHESIS 06/40 GAS</b>	CARP1522	---	---
<b>SYNTHESIS 08/50</b>	CARP1522	---	---
<b>SYNTHESIS 11/65</b>	CARP1522	---	---
<b>SYNTHESIS 12/80</b>	CARP1522	---	---
<b>SYNTHESIS 12/100 EL</b>	---	CARP1218	CARP1219
<b>SYNTHESIS 12/100 GAS</b>	---	CARP1218	CARP1219

		06/40 BM	08/50 BM	11/65 BM	12/80 BM	12/100 BM
⑧	<b>Ruota posteriore senza freno</b> Back wheel without brake <i>Rueda posterior sin freno</i> <b>Roue posterieure sans frein</b> HINTERRAD OHNE BREMSE	RUOT0027	RUOT0027	RUOT0027	RUOT0027	RUOT0026
⑨	<b>Rinforzo traversa</b> Crosspiece reinforcement <i>Refuerzo para travesa</i> <b>Renforcement traverse</b> VERSTÄRKUNG FÜR TRAVERSE	CARP1608	CARP1608	CARP1608	CARP1608	CARP1120
⑩	<b>Ruota anteriore con freno</b> Front wheel with brake <i>Rueda anterior con freno</i> <b>Roue anterieure avec frein</b> VORDERRAD MIT BREMSE	RUOT0026	RUOT0026	RUOT0026	RUOT0026	RUOT0001

---

**⚠ Per la pulizia delle superfici esterne in acciaio inox utilizzare una spugna morbida inumidita, eventualmente con un detersivo leggero, non abrasivo.**

**⊘ Non usare detersivi abrasivi o corrosivi, poiché renderebbero opaco l'acciaio inox.**

**⚠ To clean the external stainless steel surfaces, use a soft sponge dampened with a weak non abrasive detergent.**

**⊘ Do not use abrasive or corrosive detergents as these will dull the shine on the stainless steel.**

**⚠ Para la limpieza de las superficies externas en acero inox, utilizar una esponja suave, humedecida con un detergente delicado, no abrasivo.**

**⊘ No usar detergentes abrasivos o corrosivos porque el acero pierde su brillo.**

**⚠ Pour le nettoyage des surfaces externes en acier inox, utiliser une éponge douce et humide, éventuellement avec un détergent léger non abrasif.**

**⊘ Ne pas utiliser de détergents abrasifs ou corrosifs, car ils rendraient l'acier inox opaque.**

**⚠ ZUR REINIGUNG DER AUßENFLÄCHEN AUS EDELSTAHL EINEN WEICHEN FEUCHTEN SCHWAMM VERWENDEN, EVENTUELL MIT EINEM LEICHTEN, NICHTSCHEUERNDEN SPÜLMITTEL.**

**⊘ KEINE SCHEUERENDE ODER KORROSIVE REINIGUNGSMITTEL VERWENDEN, WEIL DIESE DEN EDELSTAHL MATT MACHEN WERDEN.**

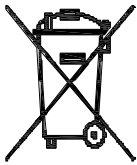

**Raccolta differenziata. Questo prodotto non deve essere smaltito con i normali rifiuti domestici. In base alle normative locali, i servizi per la raccolta differenziata possono essere disponibili presso i punti di raccolta municipali.**

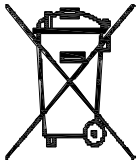

Source separation for recycling. This product must not be disposed of together with normal domestic waste. Depending on local standards and conditions, services for collecting separated waste may be available at centres provided by the local council.

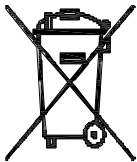

*Recolección diferenciada. Este producto no debe ser eliminado con los normales desechos domésticos. En base a las normas locales, los servicios de recolección diferenciada pueden encontrarse en los puntos de recolección municipal.*



**Collecte différenciée. Ce produit ne doit pas être jeté avec les déchets domestiques normaux. Selon les normes locales, les services pour la collecte différenciée peuvent être disponibles dans chaque point de collecte municipal.**

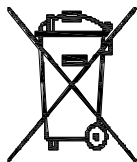

**ABFALLTRENNUNG. DIESES PRODUKT MUß MIT DEN NORMALEN HAUSABFÄLLEN NICHT ENTSORGT WERDEN. LAUT DEN LOKALEN NORMEN KÖNNEN DIE ABFALLTRENNUNGSDIENSTE BEI DEN GEMEINDESAMMLUNGSPUNKTEN ZUR VERFÜGUNG STEHEN.**

Dr. Zanolli s.r.l.  
Via Casa Quindici, 22  
37066 Caselle di Sommacampagna VR  
Tel. +39-0458581500 Fax +39-0458581455  
VAT N.IT00213620230