

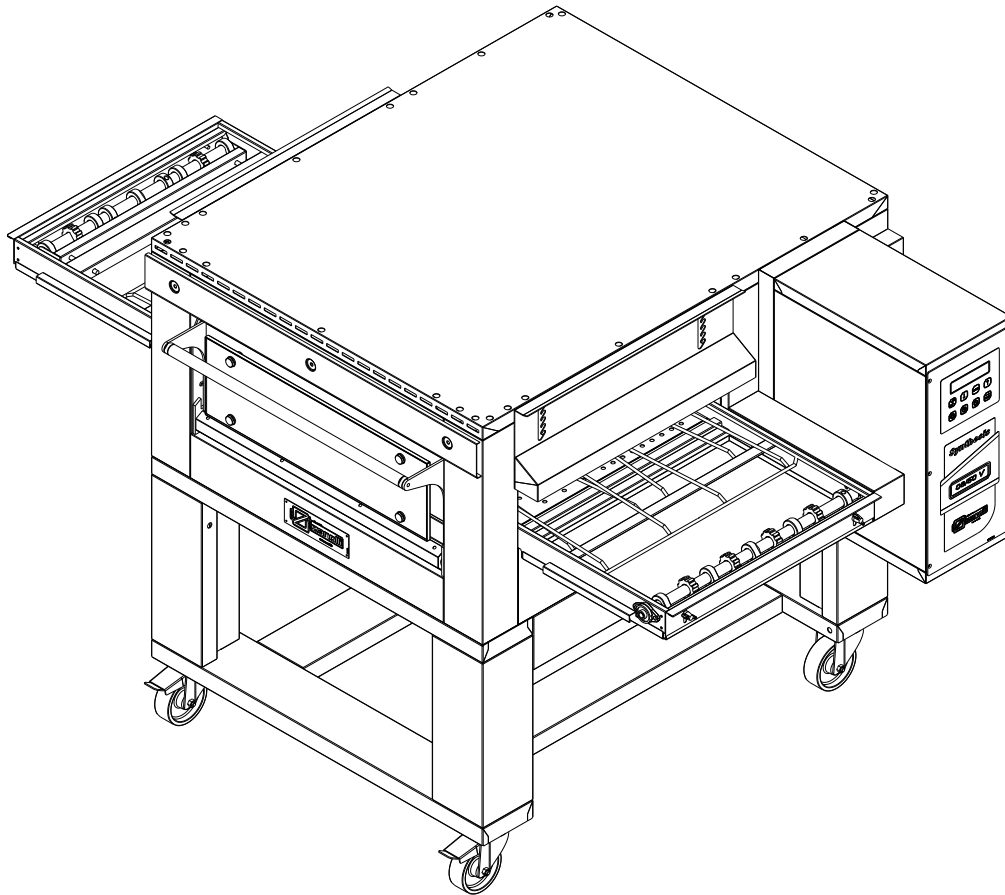

Forni e Macchine • Ovens and Machines

DR. ZANOLLI s.r.l.
Via Casa Quindici, 22
37066 Caselle di Sommacampagna
(Verona) Italy
Tel +39 045 8581500 (r.a.)
Fax +39 045 8581455
Web: www.zanolli.it • e-mail: zanolli@zanolli.it



SYNTHESIS

08/50 V P W E

Manuale di installazione, uso e manutenzione
Manual for installation, use and maintenance
Manual de instalación, uso y mantención
Notice d'installation, d'utilisation et d'entretien
INSTALLATIONS-, BEDIENUNGS- UND INSTANDHALTUNGSHANDBUCH

cod. SY0850PW.E.D.11 - rev. 0.2 del 01/09/2015



**DICHIARAZIONE DI CONFORMITÀ
DECLARATION OF CONFORMITY
DECLARACIÓN DE CONFORMIDAD
DÉCLARATION DE CONFORMITÉ
KONFORMITÄTSEKTLÄRUNG**



Noi
We / El que suscribe /
Nous / Wir

Dr. ZANOLLI s.r.l.
Via Casa Quindici, 22
37066 Caselle di Sommacampagna, VR

dichiaro sotto la nostra esclusiva responsabilità che l'apparecchiatura
*declare under our responsibility that the equipment / declara bajo su propia responsabilidad que el equipo /
déclarons sous notre responsabilité que l'appareil / erklären in alleiniger Verantwortung, daß das Gerät*

Marca

Manufactured by / Marca / Marque de fabrication / Bezeichnung

Modello

Model / Modelo / Model / Modell

N° di serie

Serial number / N° de serie / N° de série / Seriennummer

Anno di costruzione

Year of construction / Año de construcción / Année de construction / Baujahr

come descritto nella documentazione allegata, è in conformità con le seguenti direttive europee
*is in conformity with the following European Directives / es conforme con las siguientes Directivas europeas /
est conforme aux suivantes Directives européennes / auf das sich diese Erklärung bezieht, mit den E - Normen*

- 2014/35/CE Direttiva Bassa Tensione

Low Tension Directive / Directiva Baja Tension / Directive Basse Tension / Niederspannungsrichtlinie

- 2014/30/CE Direttiva Compatibilità Elettromagnetica

*Electromagnetic Compatibility Directive / Directiva Compatibilidad Electromagnetica /
Directive Compatibilité Electromagnétique / Elektromagnetische Verträglichkeit*

- 2006/42/CE Direttiva Macchine

Machines Directive / Directiva Maquinas / Directive Machines / Maschinenrichtlinie

- 1935/2004/CE Regolamento Oggetti destinati a venire in Contatto con i Prodotti Alimentari

*Regulation for Equipment intended to come into Contact with Foodstuffs / Normativa para Equipos destinados a
entrar en Contacto con Alimentos / Réglementation Objets destinés à venir en Contact avec des Produits
Alimentaires / Gesetzliche Regelung der Gegenstände, die mit Lebensmitteln in Kontakt kommen*

e con le norme cogenti alle direttive.

*and with the compulsory regulations of the Directives / y con las normas ineludibles de las Directivas /
et aux normes inéluctables des Directives / und mit den Zwangsvorschriften der Richtlinien, übereinstimmt*

Caselle di Sommacampagna

Dr. Zanolli s.r.l.
Collaudatore
Tester / Ensayador / Testateur / Prüfer

ALL. 7.2-C3 Dichiarazione di Conformità

Rev. 4 del 7/07/2014

Dr. ZANOLLI s.r.l.

Via Casa Quindici, 22
37066 Caselle di Sommacampagna (Verona) Italy
Tel. + 39 045 8581500 (r.a.)
Fax + 39 045 8581455
web: www.zanolli.it • e-mail: zanolli@zanolli.it

Capitale sociale € 93.600,00
Reg. Imprese N. 3367
Cod. Fisc./Part. IVA 00213620230
Codice Comunitario IT 00213620230
R.E.A. VERONA N. 57706
Export M. VR005011

INDEX

| | |
|--|-----------|
| 1. INTRODUCTION | 5 |
| 2. HOW TO USE THIS MANUAL | 6 |
| 3. TECHNICAL SPECIFICATIONS | 8 |
| 3.1. Identifying the product | 8 |
| 3.2. Directives compliance | 8 |
| 3.3. Foreseen range of use..... | 8 |
| 3.4. Technical Specifications | 8 |
| 4. INSTALLATION | 9 |
| 4.1. Checking on delivery | 9 |
| 4.2. Choosing a place for installation..... | 9 |
| 4.3. Moving the unit | 10 |
| 4.4. Positionig the unit on its base | 11 |
| 4.5. Positioning stacked units..... | 11 |
| 4.6. Electrical connection..... | 11 |
| 4.7. Exhaust produced by combustion..... | 12 |
| 4.8. Checking before starting work | 12 |
| 5. OPERATION | 13 |
| 5.1. Control panel..... | 13 |
| 5.2. Functional states of the system..... | 14 |
| 5.2.1. Inactive state | 14 |
| 5.2.2. State of activity | 14 |
| 5.3. Settings | 15 |
| 5.3.1. Setting the current time..... | 15 |
| 5.4. Programming | 16 |
| 5.4.1. Cooking programs | 16 |
| 5.4.2. Cooking time adjustment | 17 |
| 5.4.3. Temperature adjustment..... | 17 |
| 5.4.4. Top and bottom power adjustment..... | 17 |
| 5.4.5. Economy Fuction | 19 |
| 5.4.6. Programming switching on..... | 20 |
| 5.6. Alarms..... | 21 |
| 5.6.1. “OVER 1” | 21 |
| 5.6.2. “OVER 2” | 21 |
| 5.6.3. “OVER” | 22 |
| 5.6.4. “BELT” | 22 |
| 5.6.5. “BATTERY” | 22 |
| 6.1. Preparation for use and before turning..... | 23 |
| 6.1.1. Ignition Control Panel | 23 |
| 6.1.2. Settings and start cooking | 23 |
| 6.1.3. How to turn off the oven..... | 23 |
| 7. SAFETY WARNINGS | 24 |

| | |
|--|-----------|
| 7.1. Prohibited actions and obligations towards the prevention of accidents | 24 |
| 7.1.1. Warnings for installers | 24 |
| 7.1.2. Warnings for users | 24 |
| 7.1.3. Warnings for the maintenance operator | 25 |
| 8. CLEANING | 26 |
| 8.1. Cleaning removable parts | 26 |
| 8.2. Cleaning of external parts | 27 |
| 8.3. Cleaning the baking chambers | 27 |
| 9. MAINTENANCE | 28 |
| 9.1. Error indicator | 28 |
| 9.2. Safety thermostat | 28 |
| 9.3. Replace battery | 29 |
| 10. DECOMMISSIONING AND DEMOLITION | 31 |
| TECHNICAL ENCLOSURES | |
| A. Technical Specifications | |
| B. Connections | |
| C. Wiring diagrams | |
| D. Exploded views | |

1. INTRODUCTION

The electric conveyor ovens mod. **SYNTHESIS** have been designed mainly for the automatic cooking of pizza and similar products. They are conveyor ovens. Favourable peculiarity of these particular ovens is that it is possible to make excellent baking, without controlling the same. For this reason it is possible for an unqualified staff to use the oven.

SYNTHESIS belong to the family of conveyor ovens. Another important innovation is that **SYNTHESIS**, thanks to their ventilation system, enable an excellent and uniform baking. In fact, the flow of hot air surrounds the product, removing the barrier of colder air that normally insulates it. This ensures an uniform distribution of the heat in appropriate dosage, in order to prevent the product from drying out excessively and giving it proper fragrance.

Thank you for the preference given to us. We can confidently assure you about your good choice, as our company has been committed to the production of quality items since decades, without useless restriction in the choice of the best materials.

To get the best use out of your new oven please read the information contained in this manual carefully.

2. HOW TO USE THIS MANUAL

 The paragraphs marked with this symbol contain indications essential to safety. They must all be read by installers, the end user and any employees that use the machine. Manufacturer does not assume any responsibility for damage or injury incurring as a result of ignoring the safety criteria outlined in these paragraphs.

 This symbol applied to various surfaces of the machine, shows that these can reach very high temperatures and should never be touched without taking the necessary precautions.

 This symbol, applied to various points on the machine, serves to warn the user of the presence of a non-insulated “high voltage hazard” inside the machine’s casing there being enough power to constitute a fire risk or to electrocute a person.

 The paragraphs marked with this symbol contain important information to avoid causing damage to the machine. It is in the users own interests to read these paragraphs carefully.

 It is recommended that this installation, instruction and service manual be kept in close proximity to the equipment so that it can be easily and quickly consulted. The manual must accompany the equipment if it is resold as it cannot be considered complete and safe without it.

Take note of the manual code and version shown on the back cover. In the event that this copy is lost or destroyed, you can order another using these

 This manual is made up of a number of chapters. They should be read in their entirety by both installers and service personnel as well as by the end user to ensure **safety of use** and to get the best results from this product.

Some useful indications for the consultation of each chapter are given below.

Chapter 3 contains the reference standards of the oven and directions for the proper use of the same.

Chapter 4 contains all the information needed to install the machine. These are mainly aimed at specialized personnel but should be read by the end user beforehand so as to predispose the environment where the machine will be operated for the installation.

Chapters 5, 6 and 7 are intended for the user who has to learn how to use the machine. These serve as a guide to the essential operations of turning on, using and turning off of the machine under safe conditions.

Chapter 8 gives all the information necessary for the cleaning of the equipment: all those operations that must be carried out by the user to guarantee that it continues to function under safe, hygienic and sanitary conditions and continues to give the best results.

Chapter 9 gives all information necessary for periodic or extraordinary maintenance, e.g. repairing or replacing parts of the equipment.

 **These maintenance operations must be carried out by specialized personnel.**

Chapter 10 gives directions for dismantling the machine.

The technical annexes contain features related to the specific model of oven and all values which may be necessary for the selection, installation and use. This chapter should be used as a point of reference to check that the way the owner intends to use it is in line with the way the machine has been designed to operate and ensure that and ensure that information concerning the precise value of a given measurement or tolerance of the equipment is available whenever necessary.

This chapter also provides a description of the electrical equipment that comes with the machine, the exploded of equipment and a list of spare parts, to facilitate order and replace any damaged parts.

 The Manufacturer reserves the right to update the production series and instruction manuals without the obligation to update the previous production series and previously issued instruction manuals.

3. TECHNICAL SPECIFICATIONS

3.1. Identifying the product

This manual refers to conveyor oven **SYNTHESIS E**.

3.2. Directives compliance

The oven **SYNTHESIS** carry the  obligatory mark, that guaranteeing their conforming to the following European directives:

2014/35/CE low current directive;

2014/30/CE electromagnetic compatibility directive;

2006/42/CE machines directive;

1935/2004/CE Regulation objects destined for coming into contact with food products.

3.3. Foreseen range of use

The electric conveyor oven mod. Synthesis is designed to cook pizza, or similar products. It is intended for professional use in the catering industry (restaurant, pizza shop, etc..).

The normal operations are the loading and unloading of products on the conveyor, the switching on, adjusting, switching off and cleaning of the appliance.

 The use to which the product should be put as stated above and the configurations foreseen for this equipment are the only ones authorized by the Manufacturer. **Do not use these machines in any way other than that indicated in the instructions provided.**

 The use intended is only valid for equipment which is in good structural, mechanical and electrical condition.

3.4. Technical Specifications

For technical specifications refer to the following technical annexes at the end of this manual:

- A. Technical Specifications
- B. Connections
- C. Wiring diagrams
- D. Exploded views

4. INSTALLATION

 **ATTENTION!** These installation instructions are for the exclusive use of personnel qualified for the installation and maintenance of electrical equipment conceived for professional use in the foodservice industry and community catering operations. An installation carried out by unqualified persons could cause damage to the machine, to people, animals or property

 **ATTENTION!** Proceed with the installation according to those norms in force in the country where it is being carried out.

In addition, where it is necessary to carry out modifications or adaptations to the electrical systems of the building in which the machine will be installed, whoever carries out such modifications must certify that the work has been undertaken according to current “best practices”.

4.1. Checking on delivery

Unless otherwise agreed, the products are carefully packaged in a robust structure in wood and with a sheet of nylon bubble wrap giving protection against knocks and humidity during transport. These are consigned to the freight operator in the best of condition.

We recommend, however, that you to check the packaging on arrival for any signs of damage. If damage has occurred, have it noted on the receipt which must be signed by the driver.

Once the equipment has been unpacked, check that it has not suffered damage. Also check that all the disassembled parts are present.

In the event of damage to the equipment and/or missing parts, bear in mind that the freight operator can only accept claims within 15 days of delivery and that the manufacturer cannot be held responsible for damage incurred to its products during their delivery. We are however, available to assist you in presenting your claim.

 **In the event of damage do not try to use the equipment and consult with professionally qualified personnel.**

4.2. Choosing a place for installation

An effective, safe and long lasting functioning of the appliance also depends on the position in which it is installed. For this reason, it is advisable to carefully consider where to install the equipment before it is delivered.

Install the appliance in a dry and easily accessible place both to facilitate its use and to carry out cleaning and maintenance.

⚠ The appliance must be installed at least 20 cm from the walls of the room or from other equipment so that the ventilation outlets located on the sides of the oven are not obstructed.

Whilst in operation, cooking equipment produces vapor and cooking smells that compromise the integrity of a healthy working environment.

⚠ A check must be made to ensure that the temperature and relative humidity never exceed the maximum and minimum values indicated in the specifications (see Enclosure A) even when the machine or other machines in the room are functioning.

Exceeding these values especially the temperature or the maximum relative humidity can easily and unexpectedly damage electrical equipment creating hazardous situations.

4.3. Moving the unit

To offload and transport the unit, use a pallet truck or a transpallet lifter with a load capacity at least equal to that of the unit. Raise the doors at the entrance and exit of the oven to the position of maximum aperture. Insert the forks into the cooking chamber by way of the tunnel entrance or exit (Fig.1).

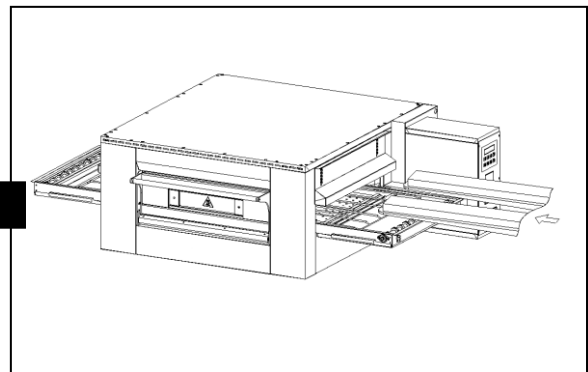

⊘ To avoid damage, place protective material between the forks and the unit.

⚠ Make sure that the lifting equipment has a lifting capacity superior to that of the weight of the load.

All responsibility for the lifting of loads rests with the person doing the lifting.

⚠ In all circumstances, to avoid unpredictable movement, be aware of the equipment's centre of mass.

⚠ Take care that children do not play with the packaging materials (e.g., plastic sheeting and Styrofoam): suffocation danger!

4.4. Positioning the unit on its base

Position the oven by sliding it into the four corners of the basement (Fig.2).

4.5. Positioning stacked units

⚠ FOR THE UNITS THAT CAN BE STACKED ONE ON TOP OF THE OTHER SEE ENCLOSURE B.

Once the first oven has been positioned on the base (see previous paragraph), overlap consecutively the second and third module fit the chimney exhaust fumes and by matching the exterior side walls of the ovens.

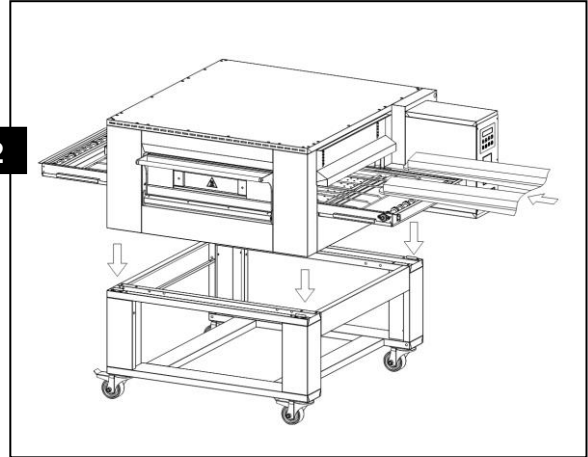

4.6. Electrical connection

⚠ Before making any connection, check that the specifications of the electrical supply to which the equipment must be connected, correspond to the specifications of the power supply required by the apparatus itself (see Enclosure A).

⚠ The appliances are supplied with an electric connection with ground/earth cable for connecting the appliance to the power grid according to the supply required (see Enclosure A).

In compliance with the safety norms in force. **It is obligatory to connect the ground/earth cable (yellow-green) to an earthing system with the same dispersion capacity as the appliance itself. The efficiency of this system must be correctly verified according to the norms in force.**

The power cable must terminate with a plug to connect to the electrical switchgear having a corresponding differential magneto thermal switch.

⚠ The equipment is not supplied with a power plug.

The coupling between plug and socket must be such that the earth conductor is connected first and disconnected last and must have the right dimensions for the rated current (see Enclosure A). Plugs and sockets for industrial use of the type CEE17 are suitable or those which satisfy European norm EN 60309.

The thermal circuit breaker must be calibrated to the total rated current and the magnetic circuit breaker calibrated to the rated current (In the case

of ovens this is only slightly higher than rated current), while the differential mechanism must be calibrated to the 30 mA current (see Enclosure A).

The electrical socket must be easily accessible and must not require further location after the installation of the equipment. The distance between the equipment and the socket must be sufficient to avoid stretching the power cable.

For the position of the electrical power connections see Enclosure B.

 **The power cable must never be trapped under the feet or wheels of the equipment.**

 **If the power cable is damaged it must be substituted by customer support or by a qualified service engineer so as to avoid any risk.**

The Manufacturer does not accept responsibility for damage caused by failure to observe the abovementioned norms.

4.7. Exhaust produced by combustion

 **ATTENTION! Carry out the installation of the oven according to the standard defined by the norms in force for this type of equipment in the country in which it is being installed. For more information refer to these norms.**

 **The Manufacturer cannot answer for damage caused by ignoring these abovementioned norms as well as the information in this manual.**

4.8. Checking before starting work







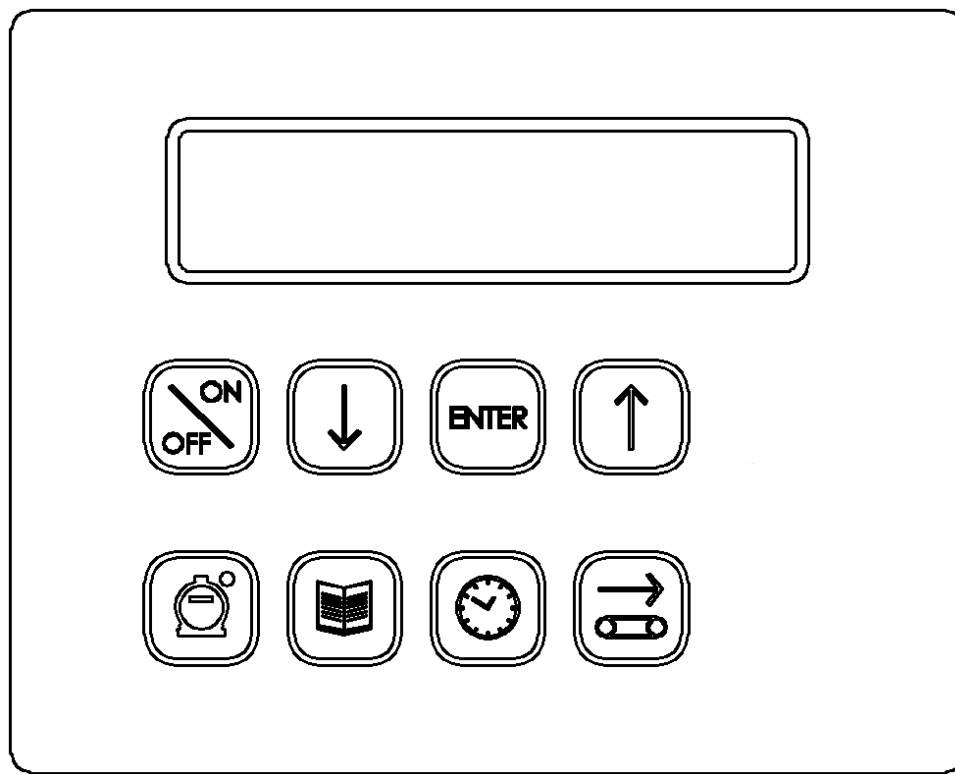

After completing installation of the unit a series of checks must be carried out, listed as follows:

- check that the various disassembled parts have been assembled.
- Check the power cable.
- Check that the control panel is working.
- Check that the apertures for ventilating the room are adequate.
- If present, check that the ventilation hood is working.

5. OPERATION

5.1. Control panel



-  Oven on-off key
-  Parameter value decrease key
-  Programme access key
-  Parameter value increase key
-  Conveyor start/stop key
-  Automatic switching on-off key
-  Economy function key
-  Cooking program setting key.

5.2. Functional states of the system

5.2.1. Inactive state

In the inactive state (Fig.1-2) the circuit board is supplied with current but all the oven's functions are disabled, apart from those for programming.

The display indicates "OFF", the current time, the day and time the oven will next be automatically switched on (if it set, Fig.2).

In the Fig. 1-2 le letters indicate:

A = current hour

B = current minute

C = day, time, minute the oven will be automatically switched on.

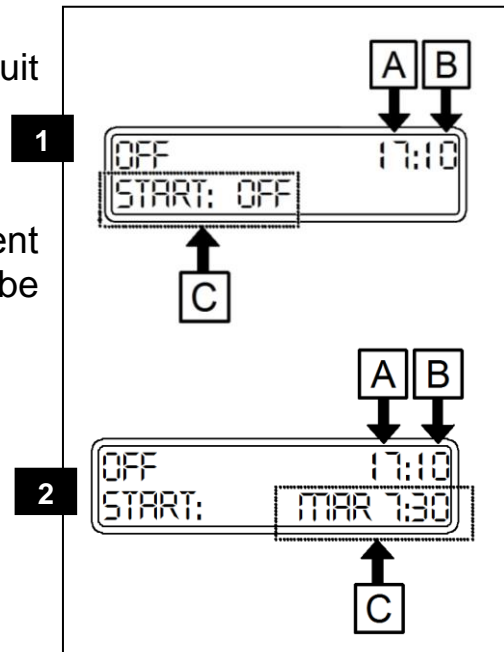

5.2.2. State of activity

When the oven is off, the rear illumination on the display is also off.

This turns on when programming is started.

Press the ON key it is entered in a state of activity: it excites the general contactor, the fan turns on and enables the heating of the oven. The backlit display turns on and shows the writing thereon in Fig.3, where:

A = Cooking temperature (°C)

B = Program set

C = Cooking time (minutes : seconds)

D = Indicator showing that the top heating element has been turned on.

E = Top heating elements power (%).

F = Economy function active if lit.

G = Bottom heating elements power (%)

H = Indicator showing that the bottom heating element has been turned on

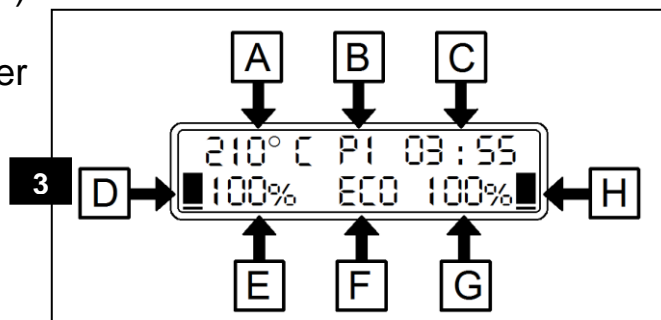

5.3. Settings

5.3.1. Setting the current time

The current time can be set by the user both when the oven is **only** off.

Press the key  for 3 consecutive seconds to enter the setting mode (Fig.4).

The display indicates (Fig.4), where:

- A = current day
- B = current month
- C = current year
- D = current hour
- E = current minute.

A cursor indicates the data being modified.

Press the  button to decide whether to change the day, month, year, hour or minutes.

The value can be adjusted using the keys 

and  (Fig.5) and confirmed press the key

 again, then move to the next data (Fig.6).

After setting day, month, year, hour and minutes, press the key  to program the current day of the week.

Appears on the display (Fig.7), where:

F = current day of the week.

5.3.2. Setting the language

The display language can be chosen from a list of available options.

To set the language, enter the clock programming mode (see chap. 5.4.1) and confirm the data until appears on the display (Fig.8).

Adjust and confirm using the same procedure as for setting the clock.

By confirming, you leave the programming mode and return to the previous mode.

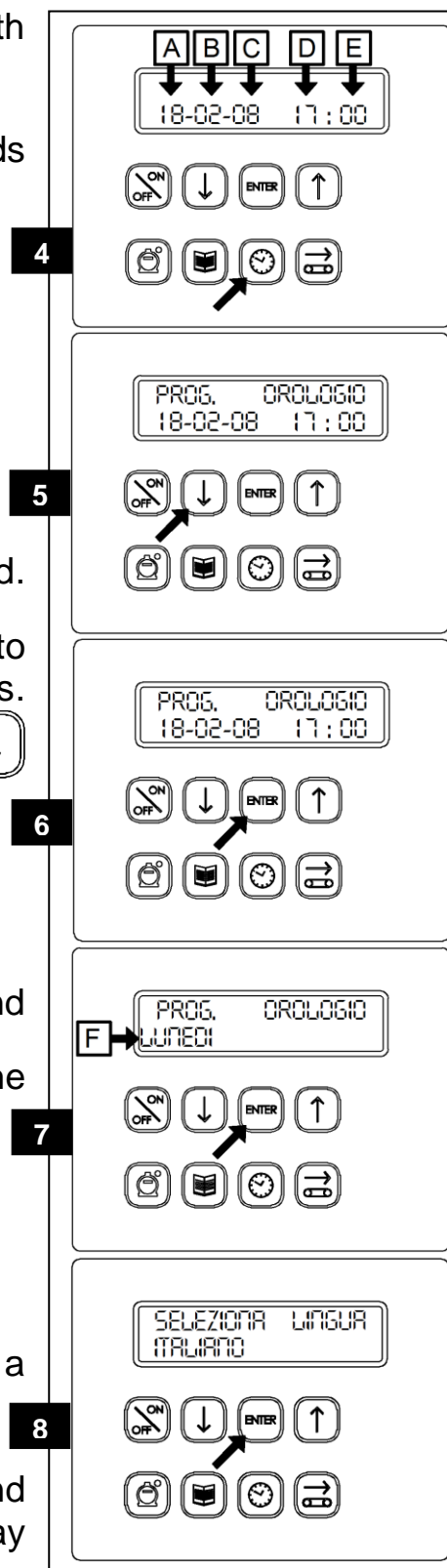

5.4. Programming

5.4.1. Cooking programs

It is possible to manage up to 6 different cooking programs. Each can be set in the following order:

1. Cooking time (minutes : seconds)
2. Temperature setting (°C).
3. Top heating element power percentage
4. Bottom heating element power percentage

These parameters are normally indicated on the display when the oven is on.

With the oven turned on it is possible to modify all the programs that can be set, with the oven turned off it is only possible to modify the last program that has been used.

Turn on the oven and press the  key to select the programme to modify (Fig.9).

Press the programming access key  to enter the programming mode and move from one parameter to the next (Fig.10).





A horizontal line flashes below the parameter being programmed.

The program that is being modified is always indicated at the top right of the display

To change the value, use the keys to increase and to decrease (Fig.11).

By keeping the key pressed, you increase the speed of data change.

If no key is pressed for more than 5 seconds, the displayed value is **memorised** and the oven automatically leaves the programming mode.

During the programming of the   and  keys are disabled, the  key exits programming mode.

The order of programming is as follows:

1. Cooking time
2. Temperature
3. Top heating elements power (%)
4. Bottom heating elements power (%).

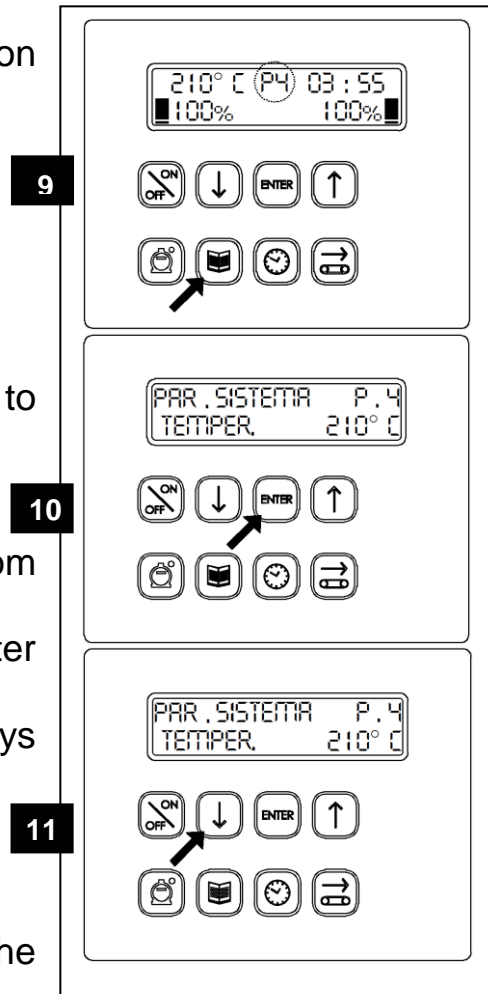

5.4.2. Cooking time adjustment

The desired cooking time is set directly by the user, and is directly connected to the relevant conveyor speed, which is automatically controlled by the electronic circuit board.

When the oven is switched on, the conveyor is still and the cooking time flashes on the display.

Press the conveyor start/stop key to activate the conveyor (Fig.12).

Conveyor can be started or stopped at any time using the key (Fig.12).

When the conveyor is still, the cooking time flashes.

12

See the paragraph 5.4.1. to set the cooking time.

5.4.3. Temperature adjustment

When the oven is on, the real temperature of the cooking chamber is indicated; press the parameter value increase key to display the set temperature (Fig.13).

13

See the paragraph 5.4.1. to learn how to adjust the set temperature.

5.4.4. Top and bottom power adjustment

To heat up of the oven, modulate the ignition of the top and bottom heating elements according to the selected power percentage, as explained hereunder.

The modulation consists in the ignition of the heating elements for a fixed time, on a period of 45 seconds in total.

For example if the value 20% is selected, the heating elements will be fed cyclically for 9 seconds each 45.

To avoid that heating elements are switched on at the same time, the top elements are on at the beginning of the period, while the bottom elements are on at the end.

For instance, if the value 30% is selected for the top heating elements, and the value 20% is selected for the bottom heating elements, the working cycle is effected as shown below:

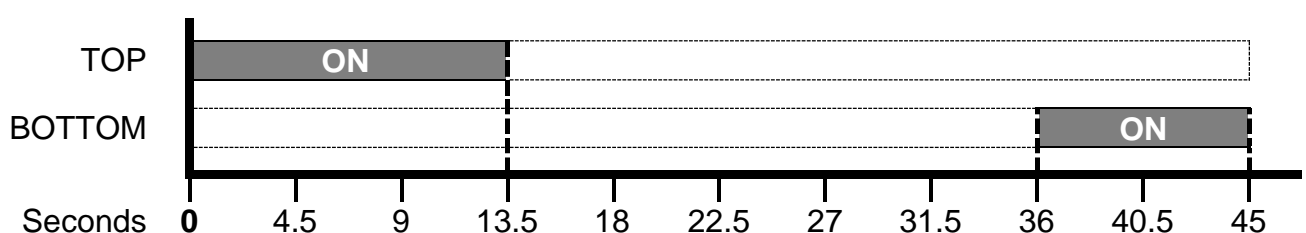

On the display you can read the percentage of ignition of the heating elements (B = top heating elements %, C = bottom heating elements %).

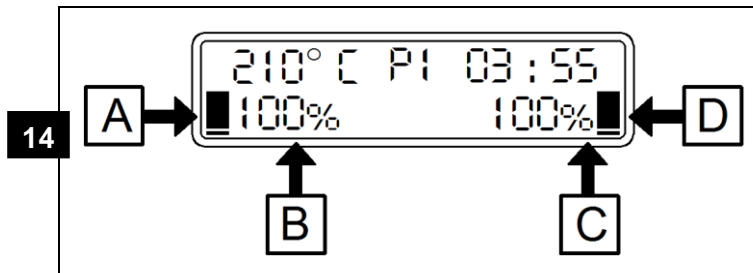

When the heating elements are switched on, on the display the indicator A for the top and D for the bottom is shown.

If the value 0% is selected, the relevant group of heating elements never turns on.

See the paragraph 5.4.1 to learn how to set the power parameters of top and bottom heating elements and how to set the cooking time.

5.4.5. Economy Fuction

 The Economy function allows the oven, when left idle, to be kept at a lower temperature than that when it is in use.



This saves energy and consequently money.

Apart from managing the temperature of the oven this can determine whether the wire mesh conveyer moves or not.

 **It is recommended to set a temperature at 50° less than the suitable cooking temperature.**

To access programming of the Economy function: with the oven on, keep the  key pressed for 5 seconds (Fig.15).





A horizontal line under the parameter in programming mode will flash on the display

To change the value use the  and  (Fig.16).

Keeping the key pressed increases the speed that the value changes.



To move onto the next value, press the  key.

If no key is pressed within 5 seconds, the value shown **will be memorised**.

During the programming, the   and  keys are disabled and the  key exits the programming mode

The order of programming is as follows:

1. Eco temperature

2. Mesh in Eco mode ( = enabled;  = disabled).

To activate the economy function, press the  key, the letters “Eco” will appear on the display.

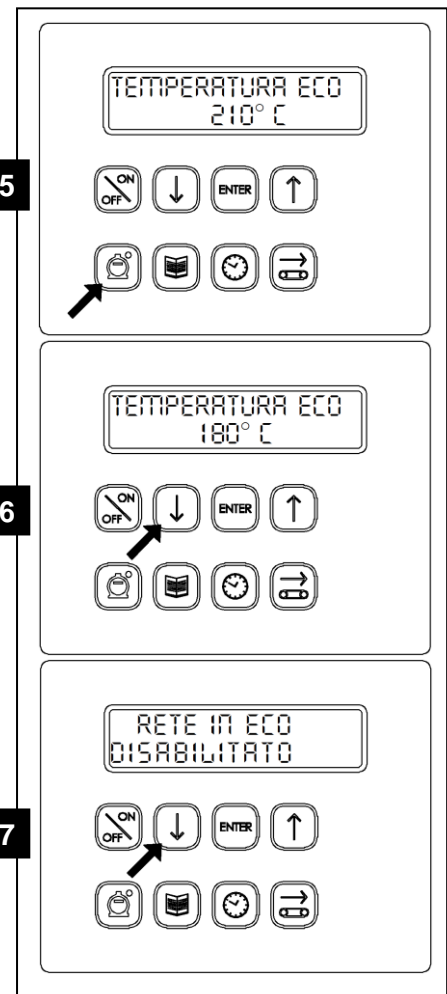



5.4.6. Programming switching on

To enter the setting mode for the programmed switching on, press and immediately release the key enable/disable auto power (Fig.18) with the oven on or off.



At first the state of the automatic switching on (active or inactive) appears on the display (AUTOSTART : ON or OFF).

To enable or disable the program must act respectively on the ignition keys to increase and to decrease (Fig.19).

Once enabled, pressing the button  is displayed on the first day of the week and the figures for the hours and minutes (Fig.20).

To select when to switch the cursor flashing in the figures for hours using the key  and then pressing the buttons to increase and decrease, you set the value (Fig.21).

If you want the oven does not turn on a specific day (eg, closing day), during the time setting, select "OFF" lying between the 23 and 00 using the keys to increase and decrease (Fig.21).

Pressing the button  again will switch to minutes and then pressing the  button again will return the cursor under the day of the week (Fig.20). To move to the next or previous to press the buttons to respectively increase and decrease.

When completed the setting, press again the button  and wait about five seconds. Data is automatically stored and you return to the previous function.

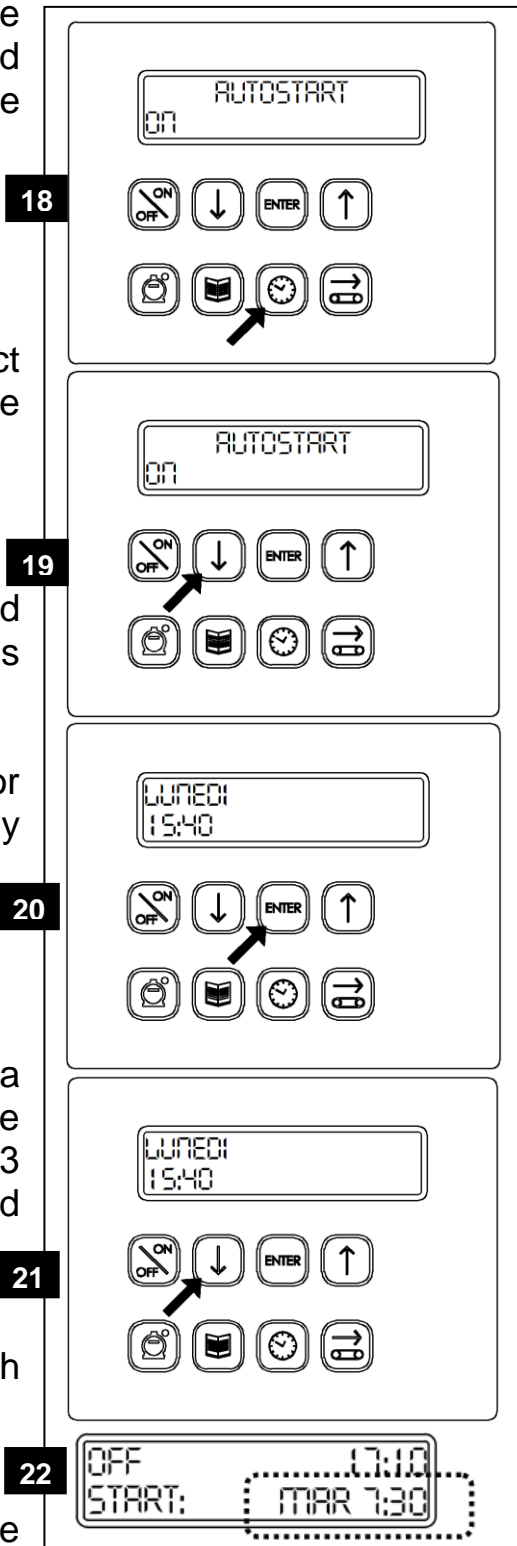

To indicate that the ignition has been enabled, in the idle state the display shows the date and time of the next time (Fig.22).). If the ignition is turned off, instead of the day and time the message appears "OFF".

5.5. Switching off the oven

Press the key  to switch off the oven (Fig.23).

The heating stops while the air recycling fan and conveyor continue working (if already on) until the temperature drops below 150°C. Then the main contactor de-energizes leaving only the circuit board powered to feed the clock and programmed switching on functions.

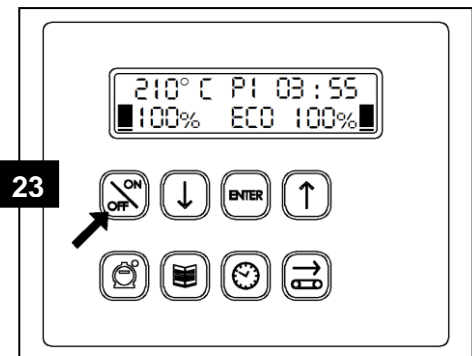

During the switching off phase the rear illumination remains on and the word "OFF" flashes. During this phase the oven can be switched back on and the conveyor can be started or stopped.

To prevent the oven being accidentally switched on, check if the display indicates the desired day and time of switching on, or, if automatic switching on is not desired, that the words "START : OFF" appear.

5.6. Alarms

The functioning of the oven is continuously checked. An alarm procedure is activated if any faults arise.

5.6.1. "OVER 1"

If the temperature measured by probe 1 exceeds 350°C or if the probe breaks, the temperature value on the display is replaced by the flashing words "OVER 1" and the alarm sounds intermittently.

The alarm can be switched off by pressing the key .

The oven continues working and only the probe 2 is used to measure the temperature. The control temperature is automatically decreased by 40°C.

This variation in the temperature value is effected to correct the only value taken in the hottest part of the oven, and to simulate a value near to the real one previously elaborated by making the average between the hottest and coldest points. This allows the oven to be used even when a probe breaks.

5.6.2. "OVER 2"

If the temperature measured by probe 2 exceeds 450°C or if the probe breaks, the temperature value on the display is replaced by the flashing words "OVER 2" and the alarm sounds intermittently.

The alarm can be switched off by pressing the key .

The oven continues working and only probe 1 is used to measure the temperature. The control temperature is automatically raised by 40°C.

This variation in the temperature value is effected to correct the only value taken in the coldest part of the oven and to simulate a value near to the real one previously elaborated by making the average between the hottest and coldest points. This allows the oven to be used even when a probe breaks.

5.6.3. “OVER”

If the temperature measured by the probe 1 exceeds 350°C and, at the same time, probe 2 exceeds 450°C, the temperature value on the display is replaced by the flashing word “OVER” and the alarm sounds intermittently.

You can switch off the alarm by pressing the key .

 Necessary to call in specialists to restore functionality

5.6.4. “BELT”



When the conveyor motor is broken or sends wrong signals to the circuit board, the word “BELT” flashes on the display and the alarm sounds intermittently.

This means that the cooking time does not correspond to the set value and that specialized personnel are required to reset the functions of the oven.

5.6.5. “BATTERY”

When the buffer battery installed on the main electronic board is exhausted, an alarm is activated on the display together with the flashing writing "BATTERY" and the acoustic signal plays in intermittent way. To replace the battery see paragraph 8.3.

6. USE

 During cooking or at the end of cooking some of the oven's surfaces reach dangerous temperatures. The  symbol warns of this danger. Never touch these surfaces and only use the proper handle.

6.1. Preparation for use and before turning

If the unit has just been installed or if it has not been used for several days before using it to work you need to clean it completely food as described in Chapter cleaning, to eliminate manufacturing waste, accumulations of dust or other substances that may contaminate food.

6.1.1. Ignition Control Panel

Press the  (Fig.1), part of the fan and heating elements

6.1.2. Settings and start cooking

Select the desired cooking program by pressing the button  (Fig.2). For programming see section 5.4.1.

After setting the cooking time and temperature required to proceed to the activation of the movement network using the button (Fig.3).

6.1.3. How to turn off the oven

At the end of each working day press the  (Fig.4).

The heating is turned off while the blower and the recirculation of the belt, if activated, will continue to operate until the temperature has dropped to below 150°C, after which de-energizes the contactor generally leaving only the supplied tab to enable the clock and power-programmed functions.

During the shutdown the backlight stays on and the word "OFF" blinks. At this stage you can still turn on the oven and start or stop the movement of the belt.

For longer periods of inactivity (for instance holidays closure) it is advisable to turn off the main switch on the electric panel, but only when the chamber fans have stopped.

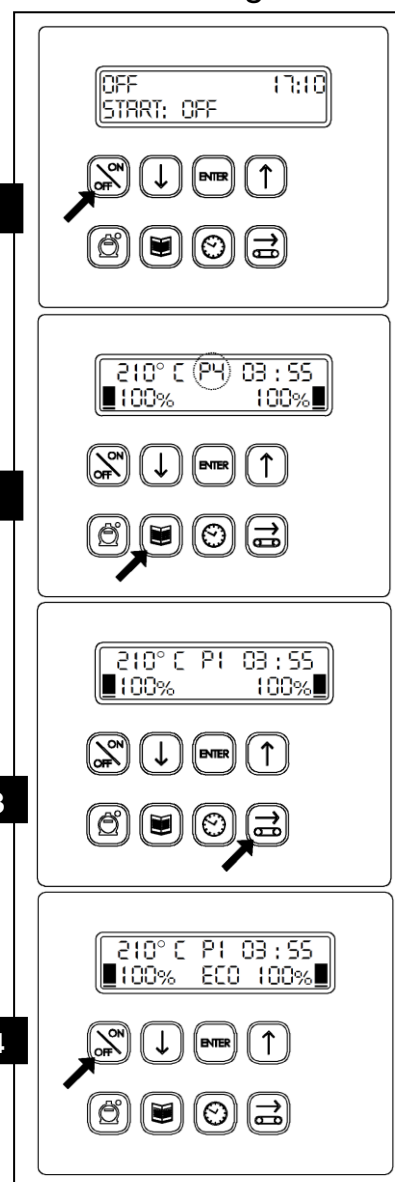

7. SAFETY WARNINGS

7.1. Prohibited actions and obligations towards the prevention of accidents

 **Read the warnings listed in this chapter carefully. They give important indications concerning safety.**

It is forbidden to install accessories that do not conform with safety standards.

Have the appliance inspected regularly by a qualified technician to guarantee your safety.

7.1.1. *Warnings for installers*

Check that the preparation for housing the appliance conforms to the local National and European regulations.

- Follow all the indications in this manual
- Do not make any overhead electrical connections using provisional or non-insulated cabling.
- Check that this electrical equipment is efficiently earthed.
- Always use personal safety devices and other means of protection foreseen by the law.

7.1.2. *Warnings for users*

The environmental conditions of the place where the appliance is to be installed must have the following characteristics:

- the area must be dry;
- be distant from sources of heat or water;
- have adequate ventilation and illumination conforming to the norms of hygiene and safety foreseen by the laws in force;
- The floor must be level and compact to facilitate thorough cleaning;
- there must not be any obstacles of any kind in the immediate vicinity that could compromise the normal ventilation of the area.

Apart from this the user must:

- make sure that children do not come close to the equipment whilst it is functioning;
- observe the rules laid out in this manual;
- not use the machine inappropriately but stick scrupulously to the use for which it was designed;
- not remove or interfere with the equipment's safety mechanisms;
- keep the safety systems in good working order;

- carry out all working procedures with the utmost safety and calm;
- respect the instructions and warnings highlighted by the signs on the equipment. These signs are to prevent accidents and must always be perfectly legible. Whenever they are damaged or illegible it is obligatory to replace them by requesting the original part from the manufacturer;
- disconnect the electricity supply after the appliance has been used,
- before carrying out cleaning or maintenance.

 **ATTENTION! Whilst the machine is working it is forbidden to remove the safety protection seeing that its parts are moving. These could cause injury to hands.**

 In the case of fire do not use liquid extinguishing agents but only those in powder form

7.1.3. Warnings for the maintenance operator

 Disconnect the electricity supply before working on electrical or electronic parts or connections.

- Always use personal safety devices and other means of protection.
- Before beginning any maintenance operations make sure that the equipment has cooled down if it has just been used.
- Should one of the safety devices not work or not be set correctly the appliance must be considered out of order.

8. CLEANING

 **Cleaning should be carried out with the equipment turned off and at room temperature having taken the precaution of disconnecting the electricity supply.**

Weekly maintenance can be carried out by the equipment's operator given that they observe the safety procedures set out in this manual. A simple but regular and careful clearing guarantees efficient performance and the normal functioning of this equipment.

 Always use person protection gear and always use tools that are appropriate for maintenance.

 Do not direct jets of water onto the equipment for clearing as these can penetrate through to and damage the electrical system with the consequent risk of electrocution and the equipment starting up unexpectedly.

 Do not use abrasive tools (abrasive sponges, etc.) because these will cause the stainless steel and glass parts to become opaque and will, quite quickly, remove the protective layer of aluminum coated sheet steel, at which point it will start to rust.

 Do not use detergents containing chlorine.

 **After the maintenance operation or repair has been carried out, reinstall all physical protection and reactivate all safety devices before putting the machine back into service.**

8.1. Cleaning removable parts

 To avoid that at some points accumulate dirt or detergent residue that may contaminate processed products, help with tools not sharp or small brushes.

It is advisable to wash the various removable parts before food residues on them dry and go hard.

Cleaning of the drawers of entry and exit should be performed every 4 hours of operation.

8.2. Cleaning of external parts

 The crystals are particularly sensitive to sudden changes in temperature that can cause them to break into tiny fragments. Do not handle the crystals and not bring them into contact with the water until they are at room temperature.

 Use a soft wet sponge with a light not abrasive detergent to clean external stainless steel or painted surfaces.

8.3. Cleaning the baking chambers

To access the internal components of the baking chamber, proceed as follows:

1. Disconnect the power supply to the oven by turning off the mains. Use the switch on the mains fuse box.
2. Remove the drawers at the entrance and exit of the wire mesh conveyor belt.
3. Remove the casing covering the conveyor belt transmission joint freeing it from its attachment with an upward movement.
4. Rotate the wire mesh conveyor until the drive shaft pivot corresponds with the transmission joint notch.
5. Slide the joint towards the control panel freeing it from the conveyor belt drive shaft.
6. Raise the shutters at the entrance and exit to the point of maximum aperture.
7. Lift the wire mesh conveyor belt from both ends and remove it in the direction of the controls.
8. Open the side hatch and unbolt the nuts using a number 8 spanner. Making sure to wear a pair of heavy duty gloves to avoid getting scratched from sharp metal corners and take out the diffusers.
9. To clean the removable parts, follow the instructions contained in paragraph 8.1. To clean inside the baking chamber, remove food deposits with a dustpan and brush or with a vacuum cleaner before cleaning the metal surfaces with a sponge wetted with water and a non abrasive or corrosive detergent, then wash these surfaces with a sponge soaked in clean water.
10. After cleaning the equipment reassemble all the components by following the instructions above in reverse order.

It is recommended to clean the oven after it has been in operation for more than 200 hours.

9. MAINTENANCE

 **WARNING!** These use and maintenance instructions are intended only for staff qualified for the installation and maintenance of electrical equipment. Maintenance by other persons may cause damage to the equipment, persons, animals or things.

 In the majority of cases it is necessary to remove the fixed guards in order to carry out repairs and checks. This also renders the voltage cables accessible.

Before carrying out any maintenance operations check that the equipment's feed cable plug is disconnected from the switchboard. Put the plug in a place where the maintenance operator can easily ascertain that it has been disconnected during all of the work done with the guards removed.

9.1. Error indicator

The electronic thermo-regulator can detect various malfunctions, for details see 5.6.

9.2. Safety thermostat

The safety thermostat intervenes when the temperature in the chamber goes above 500°C and de-activates the resistors. The safety thermostat is located on the outside of the switchboard under the conveyor belt.

To correct the error unplug the feed panel and wait for the chamber to cool down.

Unscrew the cap of the safety thermostat reset button and press the button. Resetting is not possible until the temperature in the chamber has fallen below 500°C.

 Since the safety thermostat only intervenes where there are serious malfunctions, carefully check the oven's working and repair if necessary before starting up the oven again.

9.3. Replace battery

The alarm message “BATTERY” has to be referred to the buffer battery of the electronic base board, which is over and must be replaced.

The message on the display is given together with an alarm, which intermittently sounds.

Switch off the alarm sound by pressing the key  .

For replacing the battery it is necessary to remove the fixed guards on the electric panel.

 Before carrying out any maintenance operations check that the main cable plug is disconnected from the power.

The battery is located in the middle of the electronic base board, see fig. 8.1; for replacing the battery, please follow carefully the steps listed below:

- switch off the oven and disconnect it from the main power;
- remove the guards of the electronic panel;
- replace the old battery with a new one;
- connect the oven to the power and switch it on;
- set the current time (see paragraph 5.4.1);
- switch off the oven again and disconnect it from the main power;
- connect the oven to the power and switch it on again.

Now everything is ok, your battery won't give any other alarm; and you can start working.

In case the “BATTERY” alarm still remains after replacing the battery, please don't forget to set the clock of the base board (see

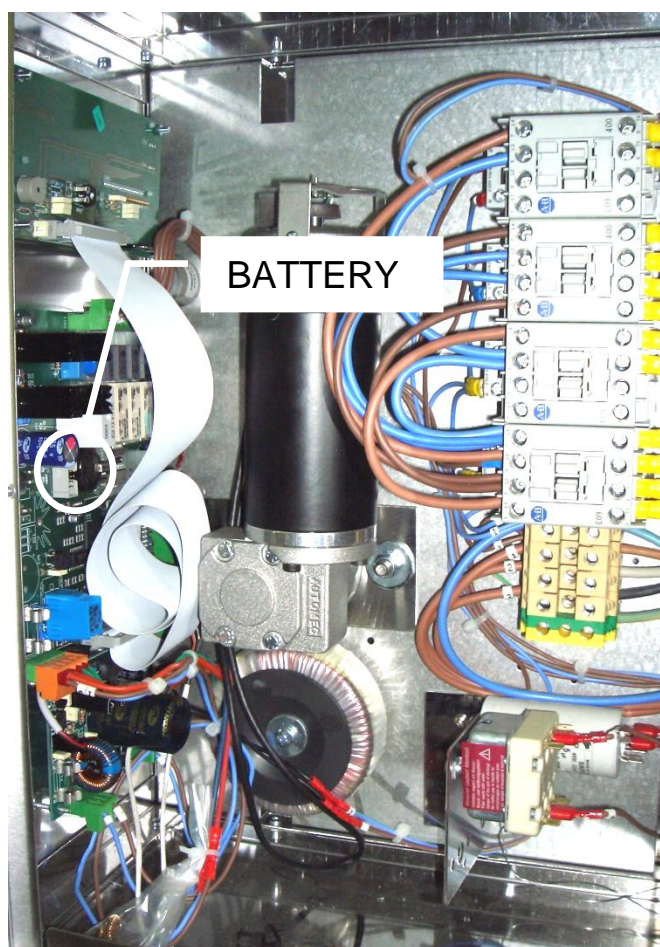

Fig. 8.1 Electronic panel, position of the BATTERY.

paragraph 5.3.1). Then disconnect the oven from the main power and connect it again.

This operation permits to reset the base board and delete any other alarms in memory.

10. DECOMMISSIONING AND DEMOLITION

Before proceeding with the decommissioning disconnect the electrical supplies to the equipment and any other connections there may be and then move the modules using suitable means such as: forklift trucks, hoists, and so on.

The machines are made up of the following materials: stainless steel, coated steel, glass, ceramic material, rock wool and electrical parts.

For the purposes of demolition therefore the materials have to be separated in observance with the norms in force in the place where the machine is being dismantled.



Separate collection. This product must not be disposed of with normal household waste. Local RAEE regulations may provide for separate collection of this kind of product.

SYNTHESIS 08/50 PW E

Allegati tecnici
Technical enclosures
Anexos técnicos
Fichiers techniques joints
TECHNISCHE ANLAGEN

A. Caratteristiche tecniche Synthesis 08/50 PW E

A. Technical specifications Synthesis 08/50 PW E

A. Especificaciones técnicas Synthesis 08/50 PW E

| ITALIANO | ENGLISH | ESPAÑOL | |
|--|------------------------------|--|--|
| Peso | Weight | <i>Peso</i> | 180 kg |
| Dimensioni esterne | Overall dimensions | <i>Dimensiones externas</i> | 1260x1750x490 mm |
| Larghezza rete | Conveyor width | <i>Amplitud red</i> | 500 mm |
| Lunghezza rete | Conveyor length | <i>Longitud red</i> | 1670 mm |
| Lunghezza camera | Chamber length | <i>Longitud cámara</i> | 850 mm |
| Capacità produttiva | Output per hour | <i>Capacidad productiva</i> | 20-17 (60-50 pizzas/h ø 30 cm) Kg/h |
| Alimentazione elettrica | Electrical power | <i>Alimentación eléctrica</i> | Trifase <i>Three-Phase</i> <i>Trifásica</i> |
| Tensione | Voltage | <i>Tensión</i> | 230/400 Vac |
| Frequenza | Frequency | <i>Frecuencia</i> | 50 o 60 Hz |
| Synthesis 08/50 PW E Power | | | |
| Potenza elettrica tot. | Total electrical power | <i>Potencia eléctrica total</i> | 13,8 + 0,44 kW |
| Corrente a 230V | Current at 230V | <i>Corriente a 230V</i> | 42,2 A |
| Corrente a 400V | Current at 400V | <i>Corriente a 400V</i> | 24,4A |
| Synthesis 08/50 PW E Normal | | | |
| Potenza elettrica tot. | Total electrical power | <i>Potencia eléctrica total</i> | 11 + 0,44 kW |
| Corrente a 230V | Current at 230V | <i>Corriente a 230V</i> | 33,2 A |
| Corrente a 400V | Current at 400V | <i>Corriente a 400V</i> | 19,2 A |
| Collegamento elettrico | Electrical connection | <i>Conexión eléctrica</i> | Cavo pentapolare senza spina - Plugless five lead cable - <i>Cable pentapolar sin enchufe</i> |
| Lunghezza cavo | Cable length | <i>Longitud cable</i> | 2 m |
| Sezione conduttori | Wire section | <i>Sección conductores</i> | 4/10 mm ² |
| Controllo temperatura | Temperature control | <i>Control temperatura</i> | Elettronico computerizzato Electronic computerized <i>Electrónico computerizado</i> |
| Unità di misura temperatura | Temperature measuring unit | <i>Unidad de medida temperatura</i> | °C |
| Massima temp. impostabile | Maximum possible temperature | <i>Máxima temperatura configurable</i> | 320 °C |
| Segnalazione errori | Errors indicator | <i>Señalaciones errores</i> | Mediante display e segnalazione acustica By means of display and acoustic alarm <i>Mediante display y señalación acústica</i> |
| Condizioni ambientali - Environment - Condiciones ambientales | | | |
| Temperatura | Temperature | <i>Temperatura</i> | 0 – 40 °C |
| Umidità massima | Maximum humidity | <i>Humedad máxima</i> | 95% senza condensa without condensation <i>sin condensación</i> |
| Livello di rumore | Noise level | <i>Nivel acústico</i> | < 70 decibel |

A. Spécifications techniques Synthesis 08/50 PW E

A. TECHNISCHE SPEZIFIKATIONEN SYNTHESIS 08/50 PW E

| FRANÇAIS | DEUTSCH | |
|--|------------------------------------|--|
| Poids | GEWICHT | 180 kg |
| Dimensions ext. | AUßENABMESSUNGEN | 1260x1750x490 mm |
| Largeur ruban transp. | NETZBANDBREITE | 500 mm |
| Longueur ruban transp. | NETZBANDLÄNGE | 1670 mm |
| Longueur chambre | BACKKAMMERLÄNGE | 850 mm |
| Capacité productive | STUNDENLEISTUNG | 20-17 (60-50 pizzas/h ø 30 cm) Kg/h |
| Alimentation électr. | STROMVERSORGUNG | Triphasée DREIPHASIG |
| Tension | SPANNUNG | 230 VAC |
| Fréquence | FREQUENZ | 50 o 60 Hz |
| Synthesis 08/50 PW E Power | | |
| Puissance électrique totale | ELEKTRISCHE LEISTUNG INSGESAMT | 13,8 + 0,44 kW |
| Courant à 230V | STROM ZU 230V | 42,2 A |
| Courant à 400V | STROM ZU 400V | 24,4 A |
| Synthesis 08/50 PW E Normal | | |
| Puissance électrique totale | ELEKTRISCHE LEISTUNG INSGESAMT | 11 + 0,44 kW |
| Courant à 230V | STROM ZU 230V | 33,2 A |
| Courant à 400V | STROM ZU 400V | 19,2 A |
| Connexion électrique | ELEKTRISCHER ANSCHLUSS | Câble pentapolaire sans fiche - FÜNFPOLIGES STECKERLOSES KABEL |
| Longueur du câble | KABELLÄNGE | 2 m |
| Section conducteurs | LEITERQUERSCHNITT | 4/10 mm ² |
| Contrôle température | TEMPERATURKONTROLLE | Électronique informatisé ELEKTRONISCH COMPUTERISIERT |
| Unité de mesure température | TEMPERATUR-MAßEINHEIT | °C |
| Température max. programmable | MAXIMAL EINSTELLBARE TEMPERATUR | 320 °C |
| Signalisation d'erreur | FEHLERMELDUNG | Grâce au display et signal acoustique MITTELS DISPLAY UND SIGNALTON |
| Conditions ambiantes - UMGEBUNGSBEDINGUNGEN | | |
| Température | TEMPERATUR | 0 – 40 °C |
| Humidité maximale | MAXIMALE FEUCHTIGKEIT | 95% sans condensation OHNE KONDENSWASSER |
| Niveau de bruit | GERÄUSCHGRAD | < 70 decibel |

B. Allacciamenti alimentazione elettrica, alimentazione gas e scarico fumi per un modulo di cottura e per la sovrapposizione di massimo tre moduli di cottura

B. Connections for electrical and gas supply, exhaust for a single cooking unit and a maximum of three cooking units stacked one on top of another

B. Conexiones alimentación eléctrica, alimentación gas y descarga humos para un módulo de cocción y para la sobreposición máxima de tres módulos de cocción

B. Branchements alimentation électrique, alimentation à gaz et évacuation des fumées pour un module de cuisson et pour la superposition de trois modules de cuisson maximum

B. STROMANSCHLUß, GASANSCHLUß UND RAUCHGASABZUGANSCHLUß FÜR EIN BACKMODUL UND DAS ÜBEREINANDERLEGEN FÜR VON HÖCHSTENS DREI BACKMODULEN.

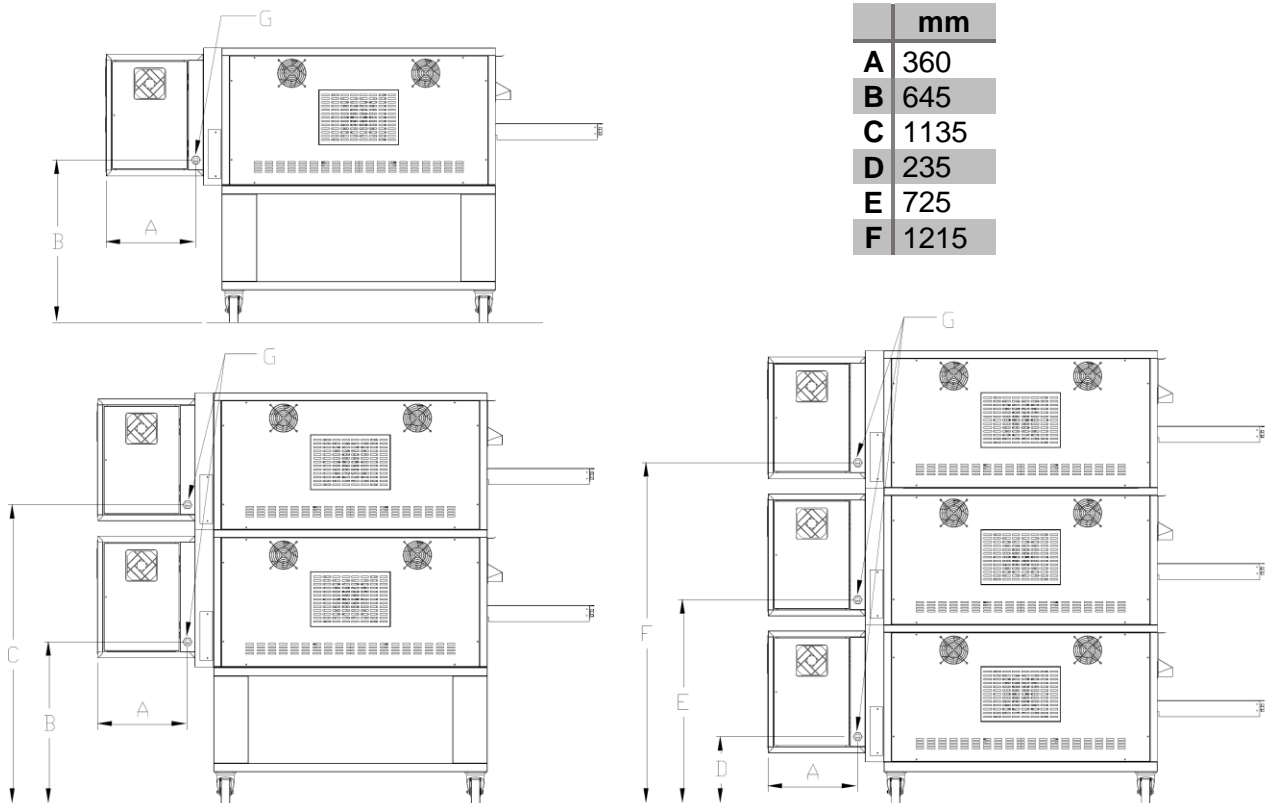

| | | | | | |
|----------|---|------------------------------|--|---------------------------------------|-----------------------|
| G | Ingresso alimentazione elettrica | Entry point for power supply | <i>Ingresso alimentación eléctrica</i> | Entrée alimentation électrique | EINGABE STROMSPEISUNG |
|----------|---|------------------------------|--|---------------------------------------|-----------------------|

C.1. Schema elettrico Synthesis 08/50 PW E

(400 Vac. ~ 3+N 50-60Hz)

C.2. Variante collegamento potenza Synthesis 08/50 PW E

(230 Vac. ~ 3 50-60Hz)

C.1. Wiring diagram Synthesis 08/50 PW E

(400 Vac. ~ 1+N 50-60Hz)

C.2. Variant power connection Synthesis 08/50 PW E

(230 Vac. ~ 3 50-60Hz)

C.1. Squema eléctrico Synthesis 08/50 PW E

(230 Vac. ~ 1+N 50-60Hz)

C.2. Variante conexión potencia Synthesis 08/50 PW E

(230 Vac. ~ 3 50-60Hz)

C.1. Schéma électrique Synthesis 08/50 PW E

(400 Vac. ~ 3+N 50-60Hz)

C.2. Variante connexion puissance Synthesis 08/50 PW E

(230 Vac. ~ 3 50-60Hz)

C.1. SCHALTPLAN SYNTHESIS 08/50 PW E

(400 Vac. ~ 1+N 50-60Hz)

C.2. VARIANTE LEISTUNGSANSCHLUSS SYNTHESIS 08/50 PW E

(230 Vac. ~ 3 50-60Hz)

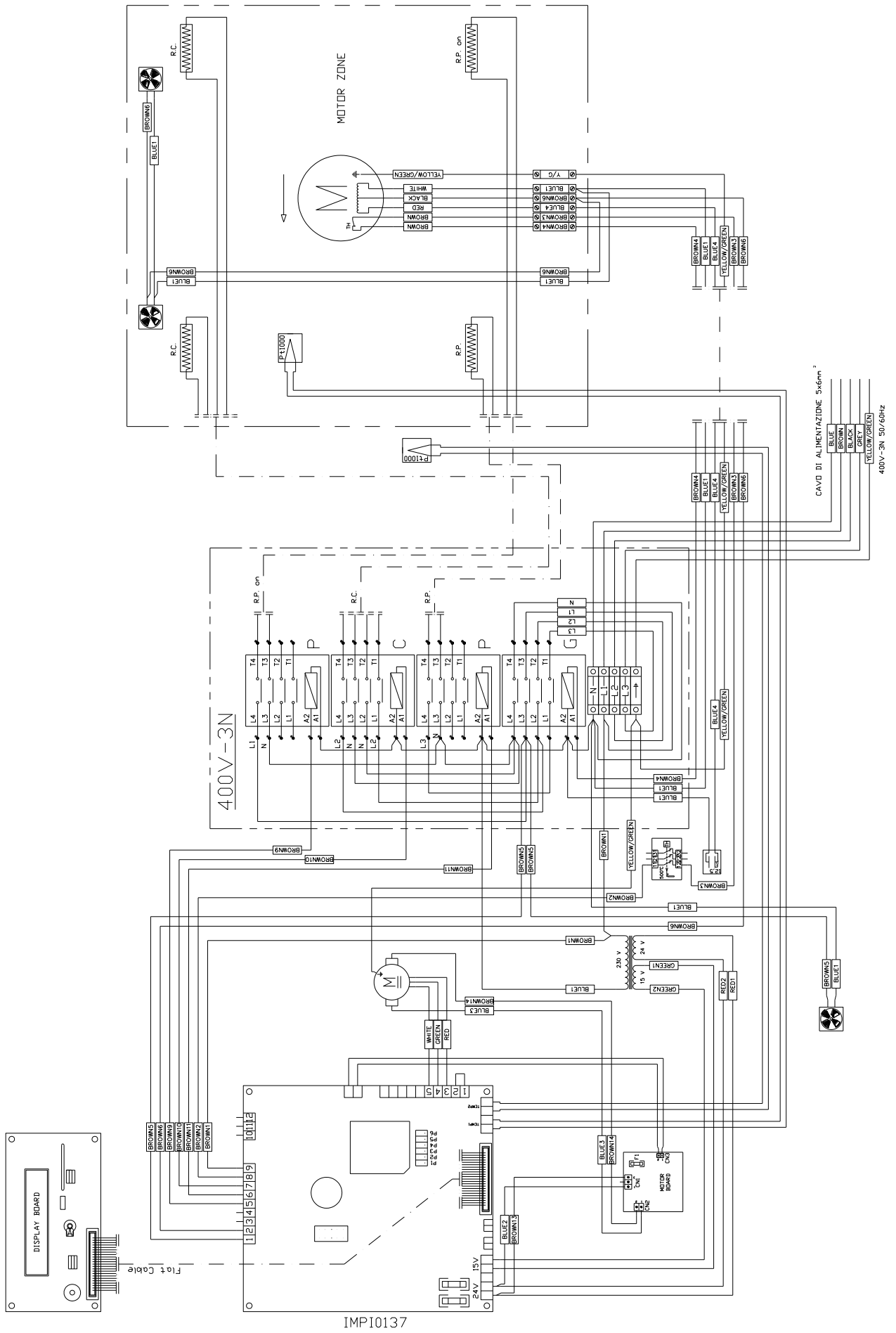

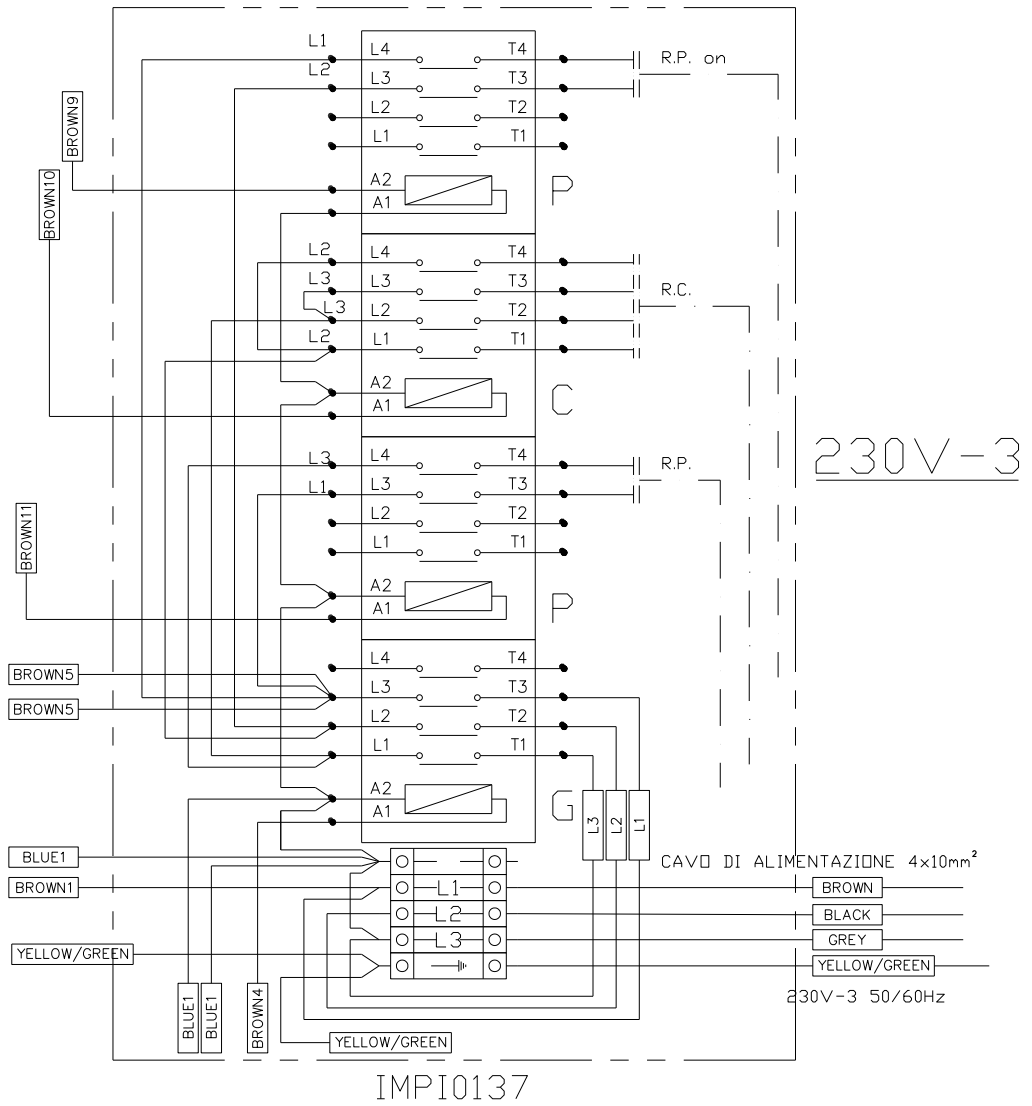

D. DISEGNI ESPLOSI ED ELENCO PARTI DI RICAMBIO

Per interventi complessi e nel caso di rotture vi preghiamo di contattarci. Comunque, allo scopo di semplificare la ricerca dei guasti e l'eventuale sostituzione delle parti danneggiate, diamo di seguito una lista delle parti di ricambio, i disegni esplosi e figure con i riferimenti a ciascuna delle parti elencate.

D. EXPLODED VIEWS AND LIST OF SPARE PARTS

For complicated maintenance works and in case of breakages we kindly ask you to contact us.

However, in order to simplify troubleshooting and possible replacement of damaged parts, we give below a list of spare parts, exploded drawings and figures with references to each party listed.

D. DIBUJOS TÉCNICOS Y LISTA DE REPUESTOS

Para interventos más complicados y en caso de rupturas, les rogamos contactarnos. En todo caso, con el fin de simplificar la búsqueda de las averías y la eventual sustitución de piezas dañadas, damos a continuación una lista de repuestos, los dibujos técnicos y figuras referentes a cada una de las piezas elencadas.

D. Dessins d'ensemble et liste des pièces de rechange

Nous vous prions de nous contacter en cas d'interventions plus complexes ou de ruptures. Toutefois, afin de simplifier la recherche des avaries et l'éventuelle substitution de pièces endommagées, vous trouverez ci-dessous une liste des pièces de rechange, les dessins d'ensemble et les figures avec les références de toutes les pièces indiquées.

D. EXPLOSIONSZEICHNUNGEN UND ERSATZTEILLISTE

BITTE SETZEN SIE SICH BEI UMFANGREICHEREN EINGRIFFEN BZW. BEI BRÜCHEN MIT UNS IN VERBINDUNG. UM DIE STÖRUNGSSUCHE UND DAS AUSWECHSELN VON EVENTUELL BESCHÄDIGTEN TEILEN ZU ERLEICHTERN, FÜHREN WIR NACHSTEHEND EINE ERSATZTEILLISTE UND DIE EXPLOSIONSZEICHNUNGEN MIT DEN BEZÜGEN DER AUFGEFÜHRTE TEILE AUF.

Tabella codici di riferimento componenti di carpenteria

List of spare component parts

Tabla códigos de referencia componentes de carpintería

| | DESCRIZIONE | DESCRIPTION | DENOMINACIÓN | |
|----|--|-------------------------------------|--|----------|
| 1 | Telaio vetro esterno porta | Door external glass frame | <i>Telar vidrio externo puerta</i> | CARP1869 |
| 2 | Maniglia porta | Door handle | <i>Manilla puerta</i> | MANI0080 |
| 3 | Giunto supporto vetro est. | Coupling for external glass support | <i>Junta soporte vidrio externo</i> | CARP1870 |
| 4 | Molla sx | Left door spring | <i>Resorte sx</i> | SPRI0009 |
| 5 | Boccola porta | Door bush | <i>Buje puerta</i> | BOCC0006 |
| 6 | Telaio portina | Door frame | <i>Telar puerta</i> | PORT0292 |
| 7 | Porta interna | Internal door | <i>Puerta interior</i> | PORT0293 |
| 8 | Staffa porta sx | Left staff | <i>Abrazadera puerta sx</i> | SUPP0206 |
| 9 | Diffusore superiore dx / inferiore sx | Upper diffuser dx / Lower sx | <i>Difusor superior dx / inferior sx</i> | CARP1439 |
| 10 | Diffusore inferiore dx / superiore sx | Lower diffuser dx / Upper sx | <i>Difusor inferior dx / superior sx</i> | CARP1440 |
| 11 | Paratoia | Cofferdam | <i>Compuerta</i> | CARP1433 |
| 12 | Cielo forno | Oven top | <i>Cielo horno</i> | FIAN0317 |
| 13 | Ventola primaria | Fan primary | <i>Ventilador primario</i> | VENT0018 |
| 14 | Pannello posteriore | Rear Panel | <i>Panel posterior</i> | FIAN0458 |
| 15 | Carter motore ventilazione inferiore | Lower ventilation motor casing | <i>Cárter motor ventilación inferior</i> | FIAN0457 |
| 16 | Carter motore ventilazione superiore | Upper ventilation motor casing | <i>Cárter motor ventilación superior</i> | FIAN0456 |
| 17 | Cielo carter comandi | Sky carter commands | <i>Cielo cárter comandos</i> | CART0131 |
| 18 | Pannello chiusura carter comandi | Command Panel carter | <i>Panel cierre cárter comandos</i> | CART0134 |
| 19 | Fascia carter comandi | Carter commands | <i>Banda cárter comandos</i> | CART0130 |
| 20 | Protezione giunto rete | Coverjoint | <i>Protección junta red</i> | CARP1437 |
| 21 | Base carter comandi | Base carter commands | <i>Base cárter comandos</i> | CART0132 |
| 22 | Bancale rete | Pallet Conveyor | <i>Bancada red</i> | CARP1427 |
| 23 | Teglia telaio rete uscita | Baking tin frame conveyor exit | <i>Bandeja telar red salida</i> | CARP1431 |
| 24 | Fermo registrabile | Stop Recording | <i>Afianzador registrable</i> | CARP1443 |
| 25 | Teglia telaio rete ingresso | Baking tin frame conveyor input | <i>Bandeja telar red ingreso</i> | CARP1432 |
| 26 | Staffa porta dx | Right staff | <i>Abrazadera puerta dx</i> | SUPP0207 |
| 27 | Molla dx | Right door spring | <i>Resorte dx</i> | SPRI0010 |
| 28 | Cristallo porta | Glass door | <i>Cristal puerta</i> | CRIS0026 |
| 29 | Ferma vetro porta | Door holder | <i>Tope vidrio puerta</i> | CARP0545 |
| 30 | Porta esterna | External door | <i>Puerta externa</i> | PORT0294 |
| 31 | Copri molla porta | Door spring cover | <i>Protección resorte puerta</i> | CARP1442 |
| 32 | Rondella gomma vetro esterno | Rubber washer for external glass | <i>Arandela goma vidrio externo</i> | GUAR0051 |
| 33 | Vetro esterno porta | Door external glass | <i>Vidrio externo puerta</i> | CRIS0076 |
| 34 | Vite supporto vetro esterno | Screw for external glass support | <i>Tornillo soporte vidrio externo</i> | CARP1871 |
| 35 | Boccola albero folle | Bush | <i>Buje árbol vacío</i> | BOCC0013 |
| 36 | Perno albero folle | Idle shaft | <i>Árbol vacío interior</i> | MECC0467 |
| 37 | Tube tendi rete | Tube tend Conveyor | <i>Árbol vacío exterior</i> | MECC0472 |
| 38 | Distanziale rete | Spacer Conveyor | <i>Distanciador red</i> | MECC0036 |
| 39 | Ruota rete | Rotate Conveyor | <i>Rueda red</i> | MECC0035 |
| 40 | Rete | Conveyor | <i>Red</i> | RETE0013 |
| 41 | Cuscinetto rete | Conveyor bearing | <i>Cojinete red</i> | CUSC0022 |
| 42 | Albero traino rete | Conveyor driving shaft | <i>Árbol arrastre red</i> | MECC0571 |
| 43 | Giunto traino rete | Conveyor Joint hub | <i>Junta arrastre red</i> | MECC0114 |

Table codes de référence composants de charpenterie

METALLBESTANDTEILE - KODENTABELLE

| | DÉSIGNATION | BESCHREIBUNG | |
|----|---|--|----------|
| 1 | Structure vitre externe porte | AUßENGLASRAHMEN TÜR | CARP1869 |
| 2 | Poignée porte | TÜRGRIFF | MANI0080 |
| 3 | Joint support vitre externe | VERBINDUNGSSTÜCK AUßENGLASSCHEIBE | CARP1870 |
| 4 | Ressort gauche | LINKE FEDER | SPRI0009 |
| 5 | Raccord porte | TÜRBÜCHSE | BOCC0006 |
| 6 | Structure porte | TÜRRAHMEN | PORT0292 |
| 7 | Porte interne | TÜRINNENSEITE | PORT0293 |
| 8 | Etrier porte gauche | LINKER TÜRHALTER | SUPP0206 |
| 9 | Diffuseur sup. droit / inf. gauche | VERTEILER OBEN RECHTS / UNTEN LINKS | CARP1439 |
| 10 | Diffuseur inf. droit / sup. gauche | VERTEILER UNTEN RECHTS / OBEN LINKS | CARP1440 |
| 11 | Vanne | PLATTE | CARP1433 |
| 12 | Voûte four | OFENDECKE | FIAN0317 |
| 13 | Ventilateur primaire | HAUPTVENTILATOR | VENT0018 |
| 14 | Panneau postérieur | HINTERE PLATTE | FIAN0458 |
| 15 | Carter moteur ventilation inférieur | MOTORABDECKUNG UNTERES GEBLÄSES | FIAN0457 |
| 16 | Carter moteur ventilation supérieur | MOTORABDECKUNG OBERES GEBLÄSES | FIAN0456 |
| 17 | Voûte carter des commandes | DECKEL ABDECKUNG SCHALTUNGSVORRICHTUNG | CART0131 |
| 18 | Panneau fermeture carter commandes | ABDECKUNGSPLATTE SCHALTUNGSVORRICHTUNG | CART0134 |
| 19 | Partie carter des commandes | ABDECKUNGSPLATTE SCHALTUNGSVORRICHTUNG | CART0130 |
| 20 | Protection joint réseau | SCHUTZABDECKUNG NETZBANDKUPPLUNG | CARP1437 |
| 21 | Base carter des commandes | GRUNDPLATTE ABDECKUNG SCHALTUNGSVORRICHTUNG | CART0132 |
| 22 | Support ruban transporteur | NETZBANDRAHMEN | CARP1427 |
| 23 | Plat structure ruban transp. sortie | BACKBLECH NETZBANDRAHMEN - AUSLAUF | CARP1431 |
| 24 | Butée réglable | EINSTELLBARER HALTER | CARP1443 |
| 25 | Plat structure ruban transp. Entrée | BACKBLECH NETZBANDRAHMEN - EINLAUF | CARP1432 |
| 26 | Etrier porte droite | RECHTER TÜRHALTER | SUPP0207 |
| 27 | Ressort droit | RECHTE FEDER | SPRI0010 |
| 28 | Verre porte | TÜRGLAS | CRIS0026 |
| 29 | Parclose porte | GLASHALTER TÜR | CARP0545 |
| 30 | Porte externe | AUßENTÜR | PORT0294 |
| 31 | Couvre ressort porte | TÜRFEDERABDECKUNG | CARP1442 |
| 32 | Rondelle en caoutchouc vitre externe | GUMMIUNTERLEGSCHIEBE AUßENGLAS | GUAR0051 |
| 33 | Vitre externe porte | AUßENGLAS TÜR | CRIS0076 |
| 34 | Vis support vitre externe | STÜTZSCHRAUBE AUßENGLAS | CARP1871 |
| 35 | Fourreau pignon fou | BUCHSE LEERLAUFWELLE | BOCC0013 |
| 36 | Pignon fou interne | INNERE LEERLAUFWELLE | MECC0467 |
| 37 | Pignon fou externe | ÄUßERE LEERLAUFWELLE | MECC0472 |
| 38 | Entretoise ruban transporteur | DISTANZSTÜCK NETZBAND | MECC0036 |
| 39 | Roue ruban transporteur | NETZBANDRAD | MECC0035 |
| 40 | Ruban transporteur | NETZBAND | RETE0013 |
| 41 | Coussinet ruban transporteur | LAGER NETZBAND | CUSC0022 |
| 42 | Arbre tendeur du ruban transporteur | ANTRIEBSWELLE | MECC0571 |
| 43 | Joint de traction ruban transporteur | NETZBANDANTRIEBSKUPPLUNG | MECC0114 |

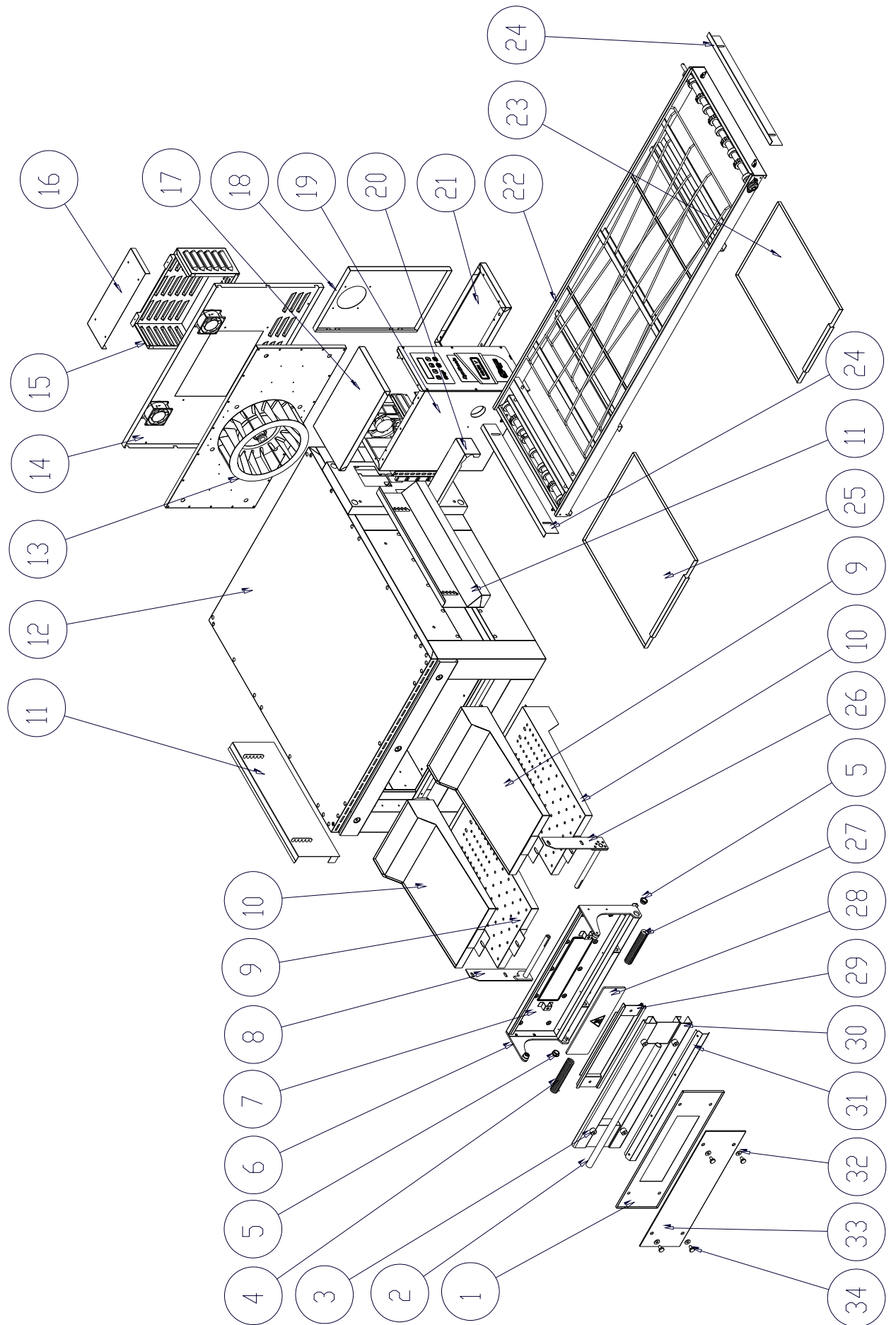



Tabella codici di riferimento componenti elettrici
 List of electrical components parts
Tabla códigos de referencia componentes eléctricos

| | DESCRIZIONE | DESCRIPTION | DENOMINACIÓN | |
|----|--|---------------------------------------|---|----------|
| 1 | Scheda display | Display Card | <i>Cédula display</i> | ELET0673 |
| 2 | Motore rete (Transtecno) | Conveyor motor (Transtecno) | <i>Motor red (Transtecno)</i> | MOTO0052 |
| | Motore rete (Automec) | Conveyor motor (Automec) | <i>Motor red (Automec)</i> | MOTO0004 |
| 3 | Scheda base | Base board | <i>Cédula base</i> | ELET0676 |
| 4 | Trasformatore toroidale per scheda base | Toroidal Transformer for Display Card | <i>Trasformador toroidal para cédula base</i> | ELET0156 |
| 5 | Scheda elettronica rete | Electronic board Conveyor | <i>Cédula electrónica red</i> | ELET0213 |
| 6 | Teleruttore 32A | Contactor 32A | <i>Telerruptor 32A</i> | ELET0002 |
| | | | | ELET0160 |
| | | | | ELET0432 |
| 7 | Morsetto 16 mm² | Terminal 16 mm ² | <i>Borne 16 mm²</i> | ELET0719 |
| 8 | Morsetto di terra 16 mm² | Earth terminal 16 mm ² | <i>Borne de tierra 16 mm²</i> | ELET0721 |
| 9 | Condensatore motore vent. | Condenser fan motor | <i>Condensa motor vent.</i> | ELET0350 |
| 10 | Termostato di sicurezza 500°C | Safety Thermostat 500°C | <i>Termostato de seguridad 500°C</i> | TERM0005 |
| 11 | Sonda PT1000 | Thermocouple PT1000 | <i>Sonda PT1000</i> | TERM0049 |
| 12 | Ventola raffreddamento | Fan cooling | <i>Ventilador enfriamiento</i> | VENT0012 |
| 13 | Griglia protezione ventola raff. | Grid Security fan cooling | <i>Reja protección vent.enfriam</i> | VENT0025 |
| 14 | Ventola raffreddamento | Fan cooling | <i>Ventilador enfriamiento</i> | VENT0024 |
| 15 | Resistenza cielo (Power) Resistenza cielo (Normal) | Top heating element (Power) | <i>Resistencia cielo (Power)</i> | RESI0081 |
| | | Top heating element (Normal) | <i>Resistencia cielo (Normal)</i> | RESI0060 |
| 16 | Resistenza platea (Power) Resistenza platea (Normal) | Bottom heating element (Power) | <i>Resistencia platea (Power)</i> | RESI0082 |
| | | Bottom heating element (Normal) | <i>Resistencia platea (Normal)</i> | RESI0061 |
| 17 | Filtro ventola raffreddamento | Filter fan cooling | <i>Filtro ventil. enfriamiento</i> | FLTR0003 |
| 18 | Pannello serigrafato | Serigraph Panel | <i>Panel serigrafado</i> | PANN0468 |
| 19 | Pulsantiera | Push button | <i>Botonera</i> | ELET0655 |
| 20 | Motore ventilazione (50Hz) Motore ventilazione (60Hz) | Fan motor (50 Hz) | <i>Motor ventilación (50Hz)</i> | MOTO0030 |
| | | Fan motor (60 Hz) | <i>Motor ventilación (60Hz)</i> | MOTO0076 |

Tableau des codes de référence composants électriques
TABELLE BEZUGSARTIKELNUMMERN ELEKTRISCHEN KOMPONENTE

| | DÉSIGNATION | BESCHREIBUNG | |
|----|--|--------------------------------------|----------|
| 1 | Carte display | DISPLAYKARTE | ELET0673 |
| 2 | Moteur ruban transporteur (Transtecno) | NETZBANDMOTOR (TRANSTECNO) | MOTO0052 |
| | Moteur ruban transporteur (Automec) | NETZBANDMOTOR (AUTOMECC) | MOTO0004 |
| 3 | Carte base | GRUNDELEKTRONIKKARTE | ELET0676 |
| 4 | Transformateur toroïdal pour carte base | RINGKERNTRANSFORMATOR FÜR BASISKARTE | ELET0156 |
| 5 | Carte électronique ruban tranp | ELEKTRONIKKARTE NETZBAND | ELET0213 |
| 6 | Télérupteur 32A | FERNSCHALTER 32A | ELET0002 |
| | | | ELET0160 |
| | | | ELET0432 |
| 7 | Borne 16 mm² | KLEMME 16 MM ² | ELET0719 |
| 8 | Borne de terre 16 mm² | ERDEKLEMME 16 MM ² | ELET0721 |
| 9 | Condensateur moteur vent. | KONDENSATOR VENTILATORMOTOR | ELET0350 |
| 10 | Thermostat de sécurité 500°C | SICHERHEITSTHERMOSTAT 500°C | TERM0005 |
| 11 | Sonde PT1000 | SONDE PT1000 | TERM0049 |
| 12 | Hélice de refroidissement | KÜHLVENTILATOR | VENT0012 |
| 13 | Grille protection hélice de refroidissement | SCHUTZGITTER KÜHLVENTILATOR | VENT0025 |
| 14 | Hélice de refroidissement | KÜHLVENTILATOR | VENT0024 |
| 15 | Résistance voûte (Power) Résistance voûte (Normal) | HEIZWIDERSTAND DECKE (POWER) | RESI0081 |
| | | HEIZWIDERSTAND DECKE (NORMAL) | RESI0060 |
| 16 | Résistance sole (Power) Résistance sole (Normal) | HEIZWIDERSTAND BODEN (POWER) | RESI0082 |
| | | HEIZWIDERSTAND BODEN (NORMAL) | RESI0061 |
| 17 | Filtre hélice de refroidissement | FILTER KÜHLVENTILATOR | FLTR0003 |
| 18 | Panneau sérigraphé | SIEBBEDRUCKTE TAFEL | PANN0468 |
| 19 | Tableau | DRUCKTASTENTAFEL | ELET0655 |
| 20 | Moteur ventilation (50 Hz) Moteur ventilation (60 Hz) | VENTILATORMOTOR (50 Hz) | MOTO0030 |
| | | VENTILATORMOTOR (60 Hz) | MOTO0076 |

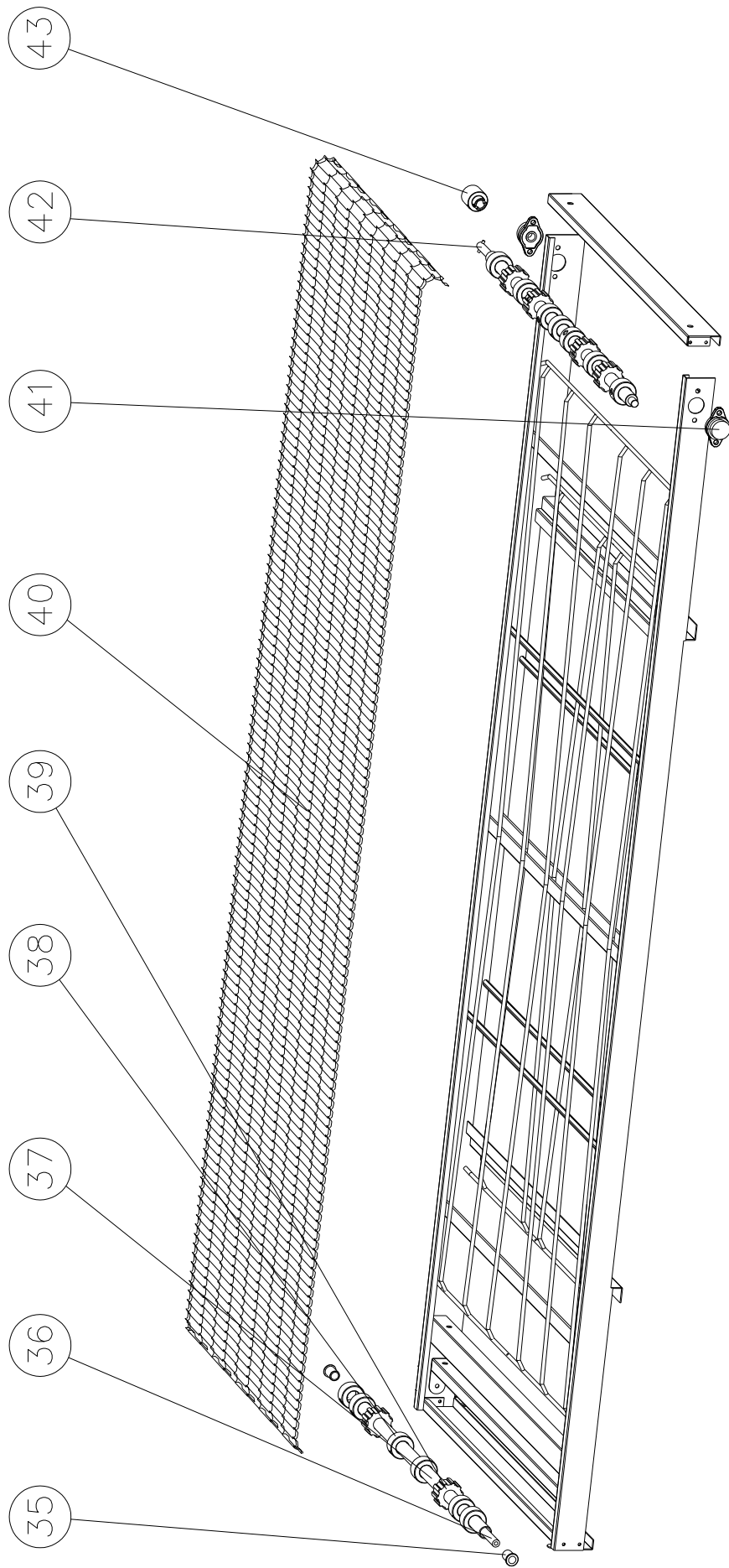
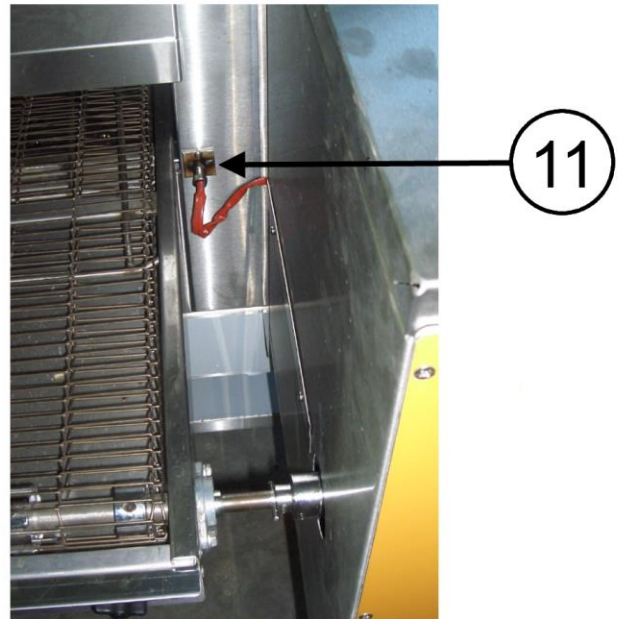
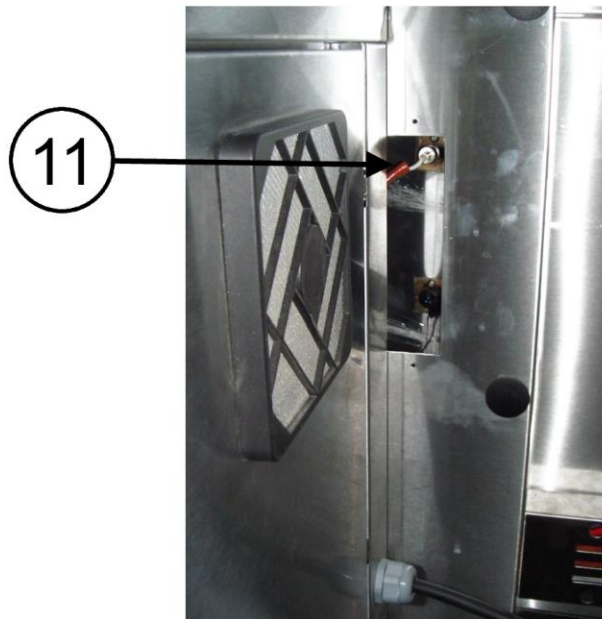
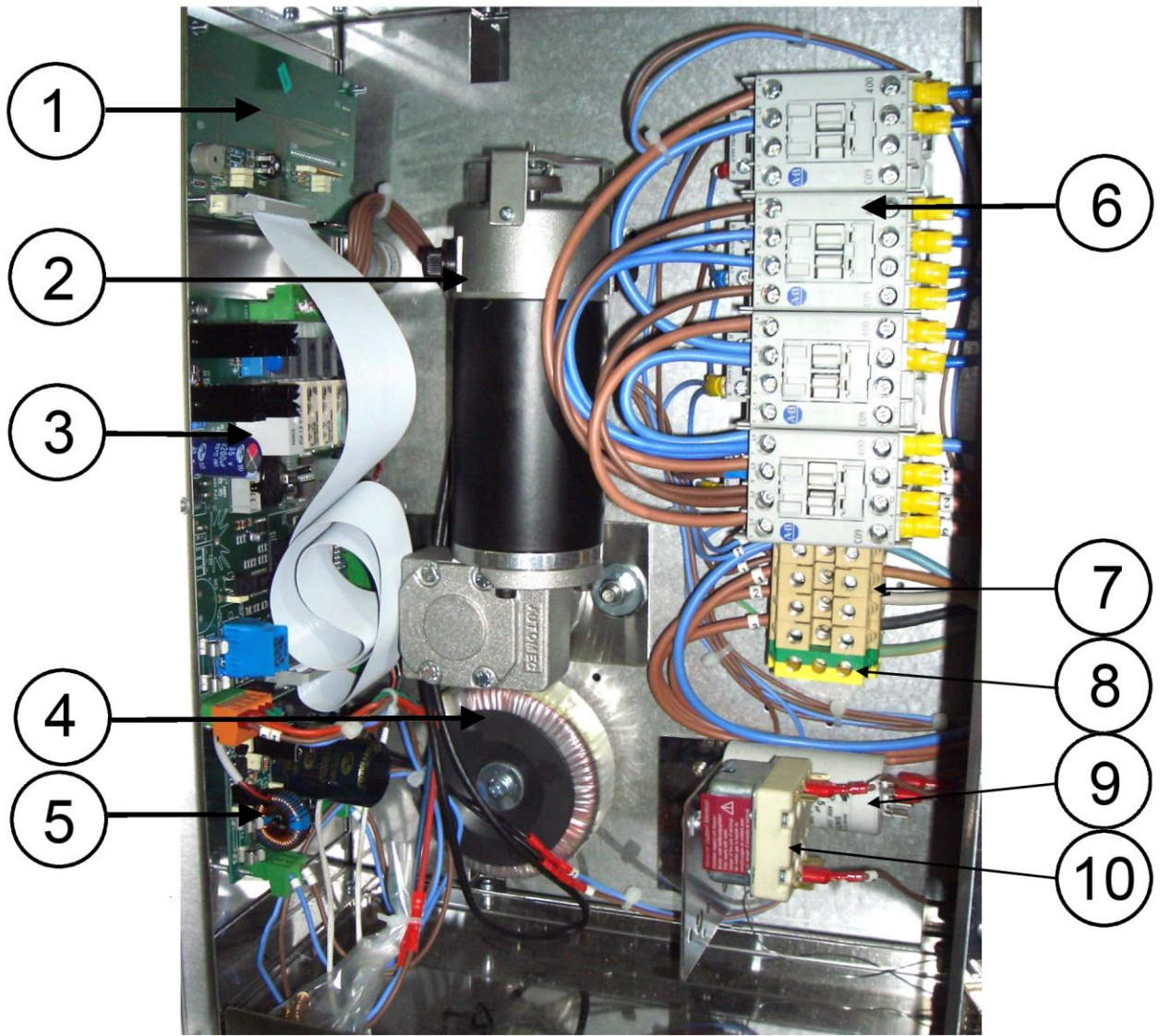

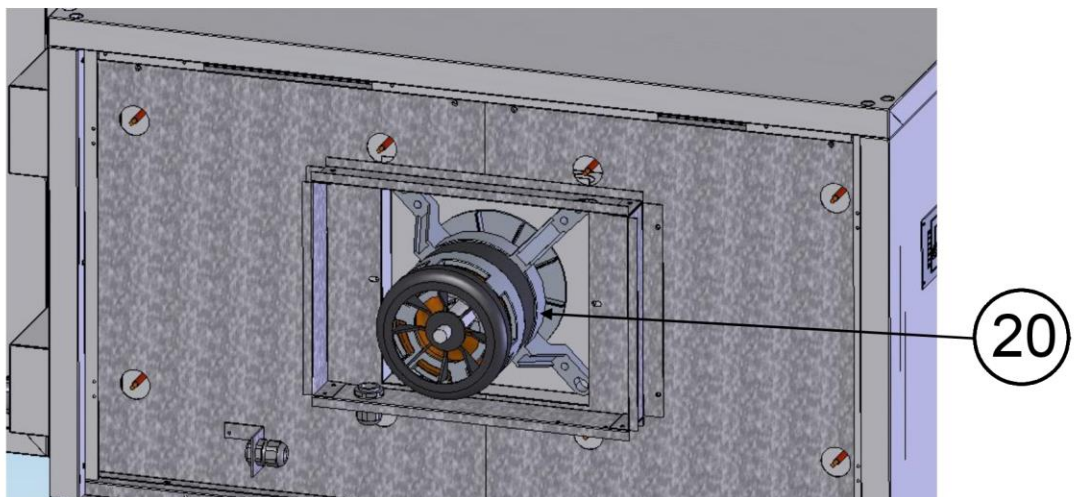
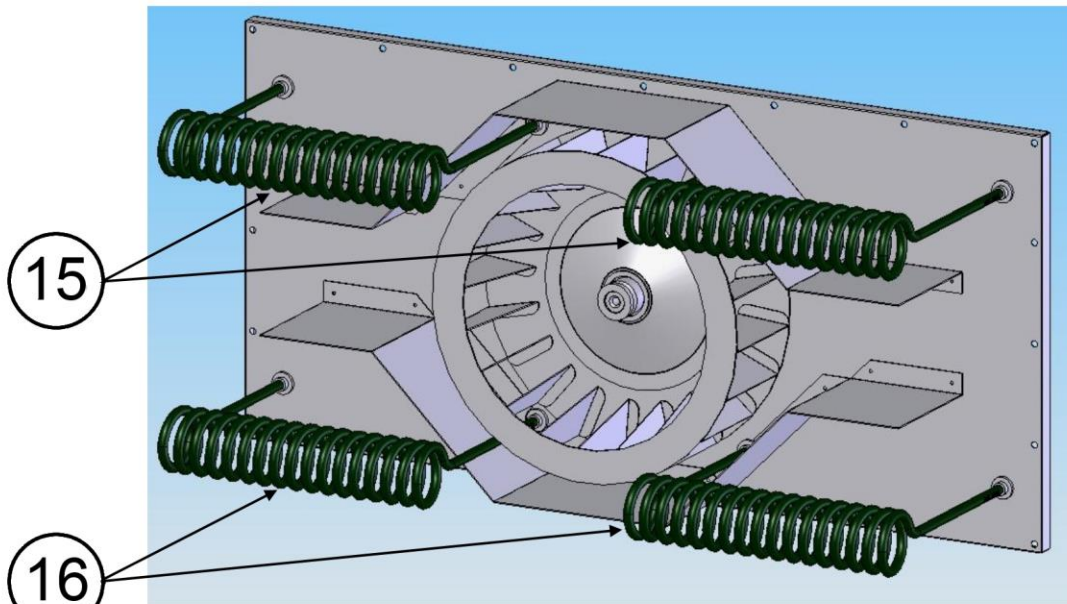

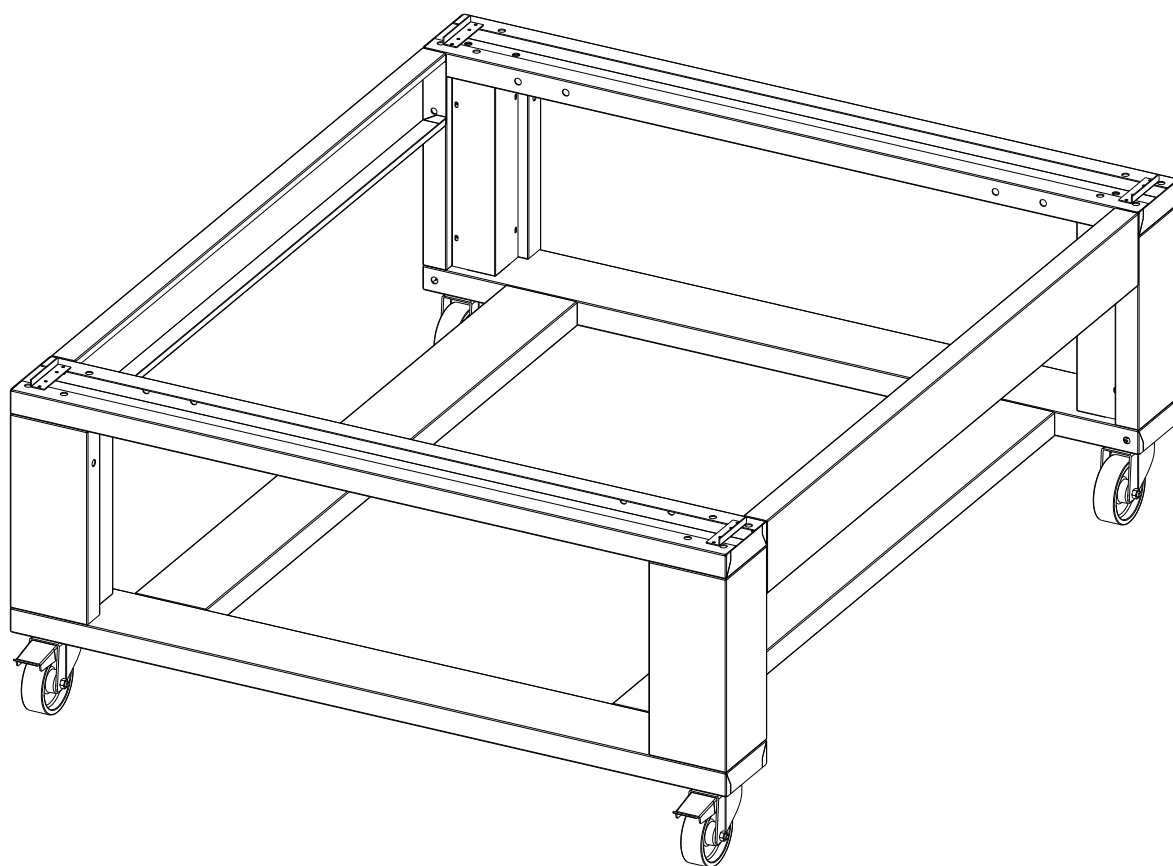

SYNTHESIS / BM

Manuale di installazione, uso e manutenzione
Manual for installation, use and maintenance
Manual de instalación, uso y manutención
Notice d'installation, d'utilisation et d'entretien
INSTALLATIONS-, BEDIENUNGS- UND INSTANDHALTUNGSHANDBUCH

1. IDENTIFICAZIONE DEL PRODOTTO

Questo manuale si riferisce ai basamenti dei forni serie Synthesis modelli: 06/40, 08/50, 11/65, 12/80, 12/100.

I basamenti dei forni sopra citati sono stati progettati per il supporto dei moduli di cottura.

1. IDENTIFYING THE PRODUCT

This manual refers to bases for the ovens 06/40, 08/50, 11/65, 12/80, 12/100 models in the Synthesis series.

The bases for ovens mentioned above have been designed to support cooking units.

1. IDENTIFICACIÓN DEL PRODUCTO

Este manual se refiere a las bases de los hornos serie Synthesis modelos: 06/40, 08/50, 11/65, 12/80, 12/100.

Las bases de los hornos previamente citados han sido proyectados como soportes de los módulos de cocción.

1. IDENTIFICATION DU PRODUIT

Ce manuel se réfère aux bases des fours série SYNTHESIS modèles : 06/40, 08/50, 11/65, 12/80, 12/100.

Les bases des fours indiqués ci-dessus ont été projetées pour le support des modules de cuisson.

1. IDENTIFIZIERUNG DES PRODUKTES

DIESE BEDIENUNGSANLEITUNG BEZIEHT SICH AUF DIE BACKÖFEN BAUREIHE SYNTHESIS MODELLE: 06/40, 08/50, 11/65, 12/80, 12/100.

DIE UNTERGESTELLE DER OBEN GENANNTEN BACKÖFEN WURDEN ZUR UNTERSTÜTZUNG DER BACKMODULE GEPLANT.

2. ISTRUZIONI DI MONTAGGIO

I basamenti vengono consegnati smontati e forniti con kit bulloneria necessario al montaggio, nelle due configurazioni previste (vedi disegni esplosi):

- A) basamento per n°1 o 2 moduli di cottura sovrapposti
- B) basamento per n°3 moduli di cottura sovrapposti.

Diamo di seguito i disegni esplosi e una lista delle parti che compongono i basamenti, con riferimenti a ciascuna delle parti elencate.

2. ASSEMBLY INSTRUCTIONS

Bases are consigned disassembled together with a kit of bolts for assembling the base in two different configurations:

- A) base for one or two cooking units stacked one on top of the other
- B) base for three cooking modules stacked one on top of the other.

An exploded diagram of the base is shown below referring to each part in the part lists that follow.

2. INSTRUCCIONES DE MONTAJE

Las bases se entregan desmontadas y con un kit tuercas necesario para el montaje, en las dos configuraciones previstas (ver dibujo técnico):

- A) base para n°1 ó 2 módulos de cocción sobrepuestos*
- B) base para n°3 módulos de cocción sobrepuestos.*

A continuación, damos los dibujos técnicos y una lista de las piezas que componen las bases, con referencia a cada una de las mismas elencadas.

2. INSTRUCTIONS POUR LE MONTAGE

Les bases sont fournies démontées et avec un kit de boulons nécessaire au montage, pour les deux configurations prévues (voir dessin explosé):

- A) base pour n°1 ou 2 modules de cuisson superposés*
- B) base pour n°3 modules de cuisson superposés.*

Vous trouverez ci-dessous les dessins éclatés et une liste des pièces qui composent les bases, avec la référence de chaque pièce de la liste.

2. INSTALLATIONSHINWEISE

DIE UNTERGESTELLE WERDEN ABMONTIERT GELIEFERT UND MIT EINEM BOLZENKIT FÜR MONTAGE IN DEN ZWEI FOLGENDEN AUSSTATTUNGEN BESCHAFFEN:

- C) UNTERGESTELL FÜR 1 ODER 2 ÜBEREINANDERLIEGENDE BACKMODULE
- D) UNTERGESTELL FÜR 3 ÜBEREINANDERLIEGENDE BACKMODULE

HIERUNTER SIND DIE EXPLOSIONSZEICHNUNGEN UND EINE LISTE DER KOMPONENTE DER UNTERGESTELLE MIT DEN BEZÜGEN DER AUFGEFÜHRTE TEILE.

A.

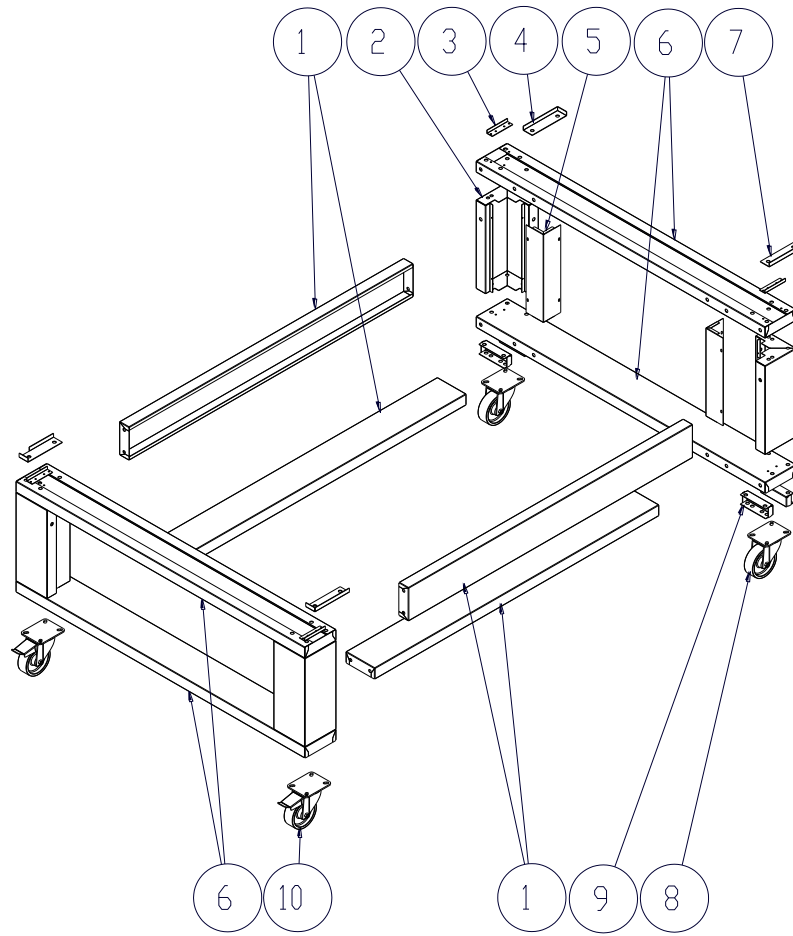

B.

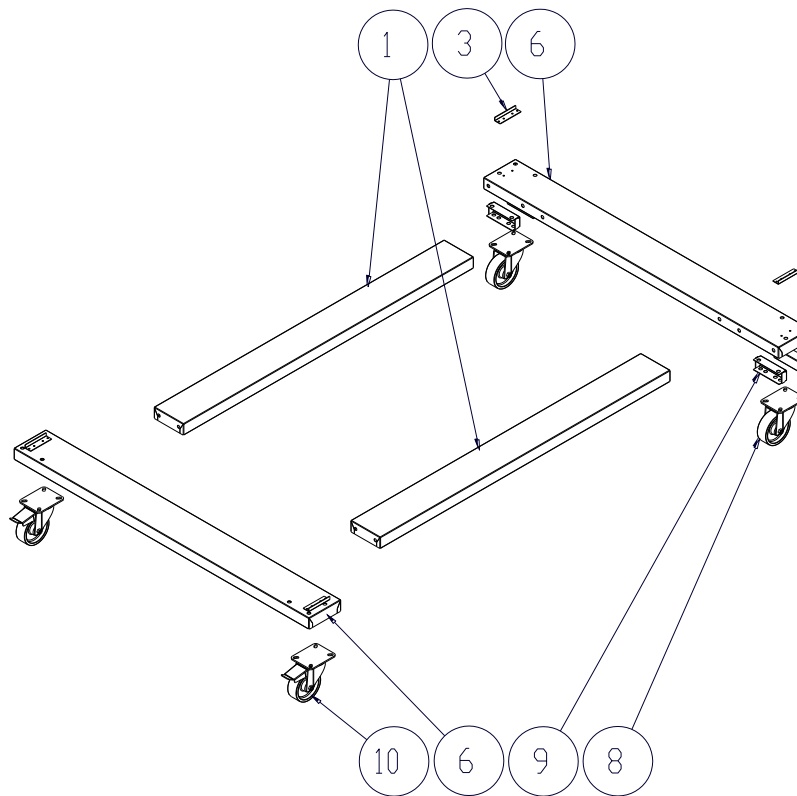

| | Traverse Crosspieces Travesaños Traverses TRAVERSE | | ②+⑤ Gambe+carter Legs+cover Pies+carter Jambes STÜTZBEIN | | |
|-----------------------------|--|----------|---|----------------------|----------------------|
| | ⑥ FRONT | ① LAT | 1 MC | 2 MC | 3 MC |
| SYNTHESIS 06/40 EL | TRAV0220 | TRAV0221 | TRAV0223 CART0266 | TRAV0223 CART0266 | TRAV0224 CART0267 |
| SYNTHESIS 06/40 GAS | TRAV0220 | TRAV0222 | TRAV0223 CART0266 | TRAV0223 CART0266 | TRAV0224 CART0267 |
| SYNTHESIS 08/50 | TRAV0167 | TRAV0166 | TRAV0195 CART0218 | TRAV0195 CART0218 | --- |
| SYNTHESIS 11/65 | TRAV0173 | TRAV0171 | TRAV0174 CART0210 | TRAV0174 CART0210 | --- |
| SYNTHESIS 12/80 | TRAV0215 | TRAV0216 | TRAV0217 CART0252 | TRAV0217 CART0252 | --- |
| SYNTHESIS 12/100 EL | TRAV0156 | TRAV0157 | TRAV0159 CART0179 | TRAV0159 CART0179 | TRAV0208 CART0236 |
| SYNTHESIS 12/100 GAS | TRAV0156 | TRAV0158 | TRAV0159 CART0179 | TRAV0159 CART0179 | TRAV0208 CART0236 |

| | Staffa fissaggio Fixing spar Abrazadera sujección Etrier de fixation BEFESTIGUNGSHALTER | | |
|-----------------------------|---|----------|----------|
| | ③ | ④ | ⑦ |
| SYNTHESIS 06/40 EL | CARP1522 | --- | --- |
| SYNTHESIS 06/40 GAS | CARP1522 | --- | --- |
| SYNTHESIS 08/50 | CARP1522 | --- | --- |
| SYNTHESIS 11/65 | CARP1522 | --- | --- |
| SYNTHESIS 12/80 | CARP1522 | --- | --- |
| SYNTHESIS 12/100 EL | --- | CARP1218 | CARP1219 |
| SYNTHESIS 12/100 GAS | --- | CARP1218 | CARP1219 |

| | | 06/40 BM | 08/50 BM | 11/65 BM | 12/80 BM | 12/100 BM |
|---|--|-------------|-------------|-------------|-------------|--------------|
| ⑧ | Ruota posteriore senza freno Back wheel without brake <i>Rueda posterior sin freno</i> Roue postérieure sans frein HINTERRAD OHNE BREMSE | RUOT0027 | RUOT0027 | RUOT0027 | RUOT0027 | RUOT0026 |
| ⑨ | Rinforzo traversa Crosspiece reinforcement <i>Refuerzo para travesía</i> Renforcement traverse VERSTÄRKUNG FÜR TRAVERSE | CARP1608 | CARP1608 | CARP1608 | CARP1608 | CARP1120 |
| ⑩ | Ruota anteriore con freno Front wheel with brake <i>Rueda anterior con freno</i> Roue antérieure avec frein VORDERRAD MIT BREMSE | RUOT0026 | RUOT0026 | RUOT0026 | RUOT0026 | RUOT0001 |

⚠ Per la pulizia delle superfici esterne in acciaio inox utilizzare una spugna morbida inumidita, eventualmente con un detersivo leggero, non abrasivo.

⊘ Non usare detersivi abrasivi o corrosivi, poiché renderebbero opaco l'acciaio inox.

⚠ To clean the external stainless steel surfaces, use a soft sponge dampened with a weak non abrasive detergent.

⊘ Do not use abrasive or corrosive detergents as these will dull the shine on the stainless steel.

⚠ Para la limpieza de las superficies externas en acero inox, utilizar una esponja suave, humedecida con un detergente delicado, no abrasivo.

⊘ No usar detergentes abrasivos o corrosivos porque el acero pierde su brillo.

⚠ Pour le nettoyage des surfaces externes en acier inox, utiliser une éponge douce et humide, éventuellement avec un détergent léger non abrasif.

⊘ Ne pas utiliser de détergents abrasifs ou corrosifs, car ils rendraient l'acier inox opaque.

⚠ ZUR REINIGUNG DER AUßENFLÄCHEN AUS EDELSTAHL EINEN WEICHEN FEUCHTEN SCHWAMM VERWENDEN, EVENTUELL MIT EINEM LEICHTEN, NICHTSCHEUERNDEN SPÜLMITTEL.

⊘ KEINE SCHEUERENDE ODER KORROSIVE REINIGUNGSMITTEL VERWENDEN, WEIL DIESE DEN EDELSTAHL MATT MACHEN WERDEN.

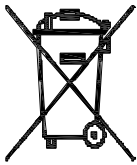

Raccolta differenziata. Questo prodotto non deve essere smaltito con i normali rifiuti domestici. In base alle normative locali, i servizi per la raccolta differenziata possono essere disponibili presso i punti di raccolta municipali.

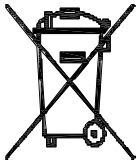

Source separation for recycling. This product must not be disposed of together with normal domestic waste. Depending on local standards and conditions, services for collecting separated waste may be available at centres provided by the local council.

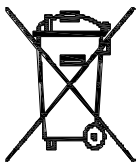

Recolección diferenciada. Este producto no debe ser eliminado con los normales desechos domésticos. En base a las normas locales, los servicios de recolección diferenciada pueden encontrarse en los puntos de recolección municipal.



Collecte différenciée. Ce produit ne doit pas être jeté avec les déchets domestiques normaux. Selon les normes locales, les services pour la collecte différenciée peuvent être disponibles dans chaque point de collecte municipal.

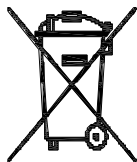

ABFALLTRENNUNG. DIESES PRODUKT MUß MIT DEN NORMALEN HAUSABFÄLLEN NICHT ENTSORGT WERDEN. LAUT DEN LOKALEN NORMEN KÖNNEN DIE ABFALLTRENNUNGSDIENSTE BEI DEN GEMEINDESAMMLUNGSPUNKTEN ZUR VERFÜGUNG STEHEN.

Dr. Zanolli s.r.l.
Via Casa Quindici, 22
37066 Caselle di Sommacampagna VR
Tel. +39-0458581500 Fax +39-0458581455
VAT N.IT00213620230