

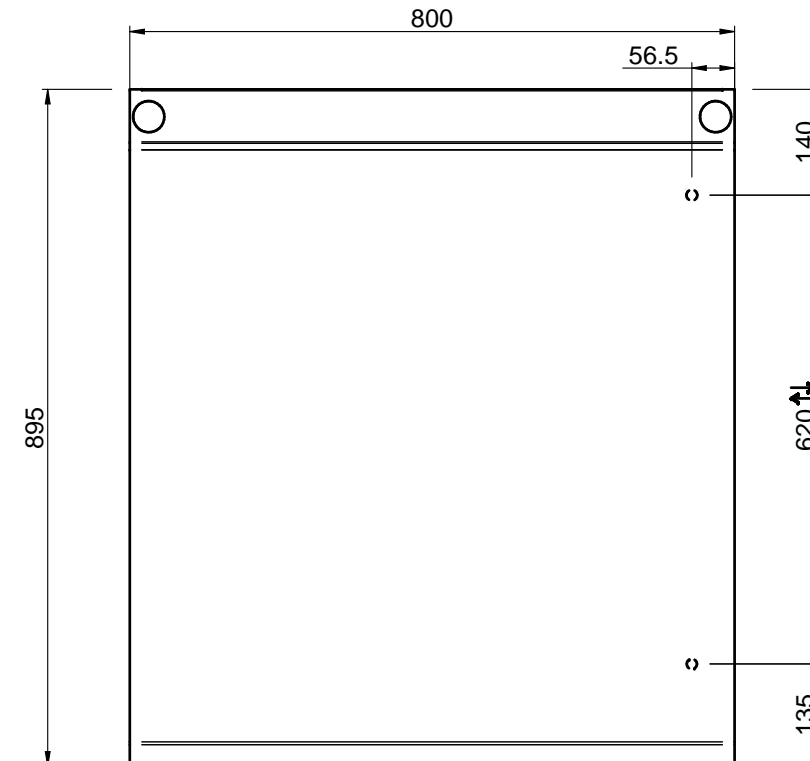

MOD : N9/PTAC4-N

Production code : N94AC

10/2023

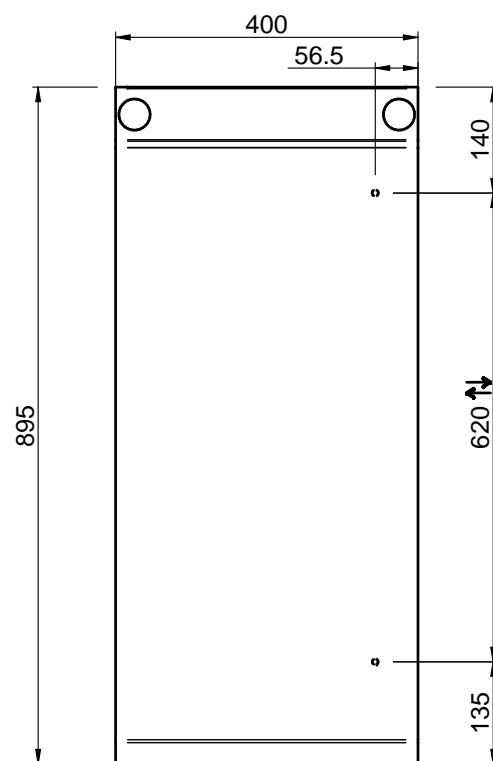
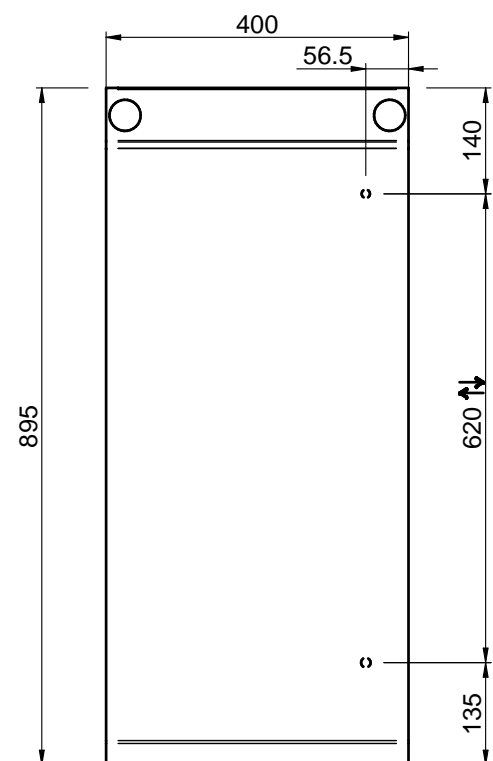
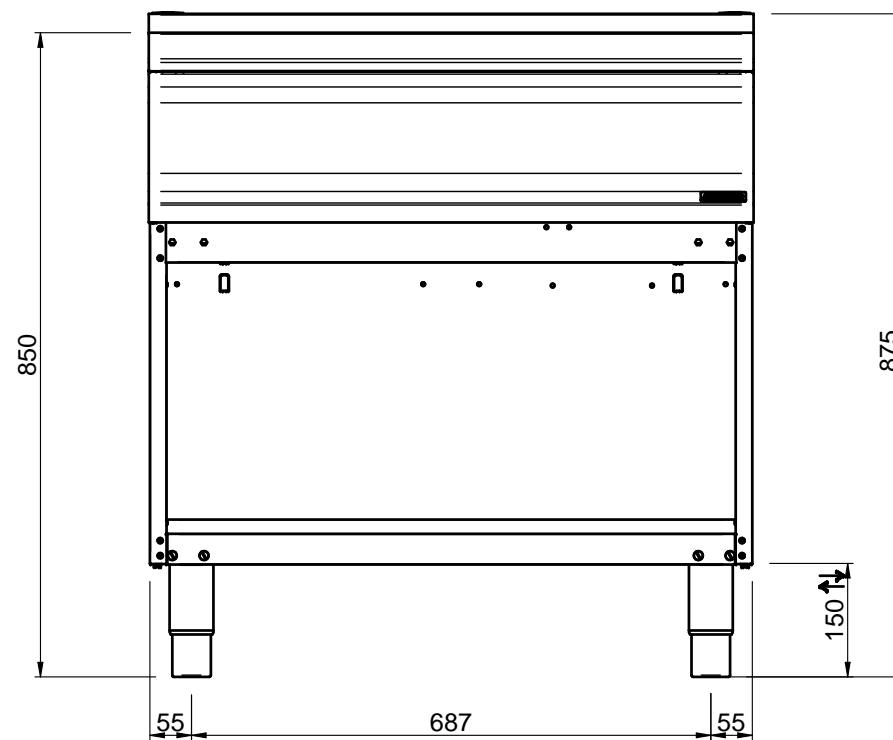
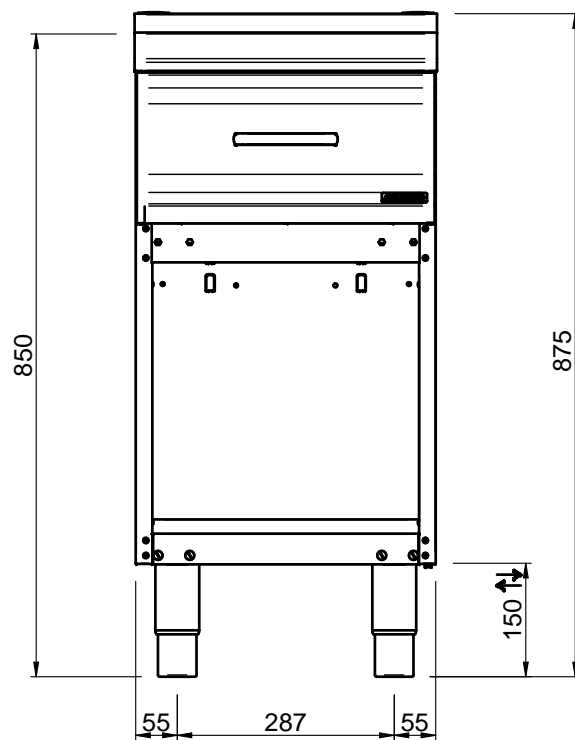
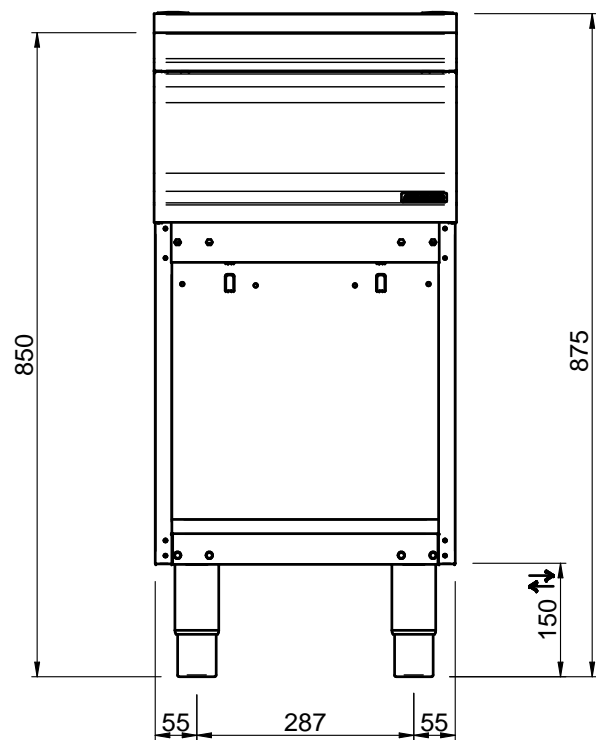

LEGENDA SIMBOLI / LEGEND



INGRESSO GAS / GAS INLET
(EN 10226-1) Ø M 1/2"



ALIMENTAZIONE ELETTRICA /
POWER SUPPLY



INGRESSO ACQUA /
WATER INLET Ø M 1/2"

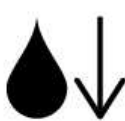

SCARICO ACQUA / OLII
WATER / OILS DRAIN



ATTACCO EQUIPOTENZIALE /
EQUIPOTENTIAL



REGOLAZIONE PIEDINI /
FEET ADJUSTMENT (h 0/+50)
/ TOP VERSION (h 0/+5)