

10/2021

Mod: MXP-45A/R2

Production code: 51203U

AIR CONDENSER UNIT

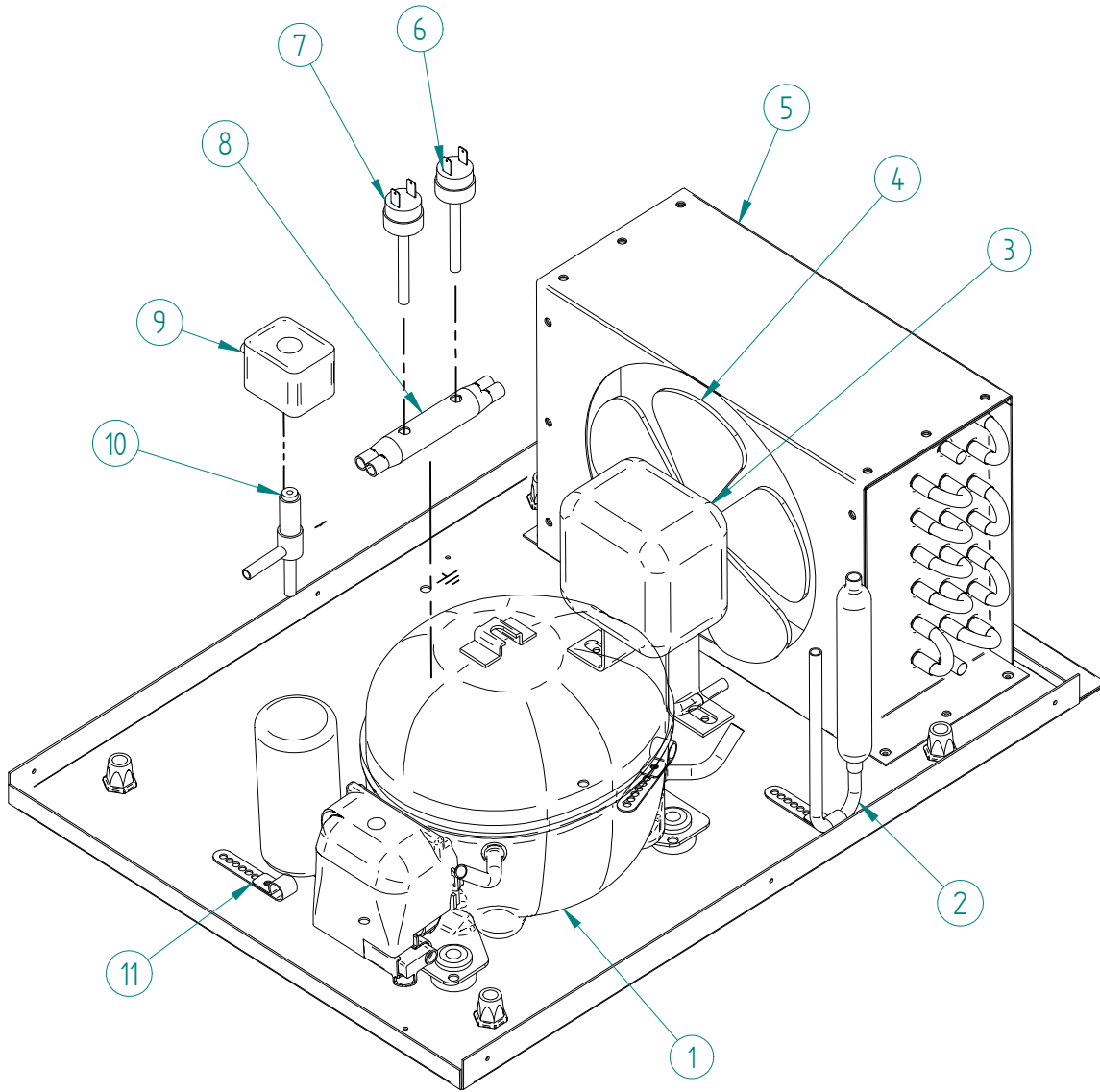

ITEM	DESCRIPTION	CODE	
		20-30	40
1	COMPRESSOR 220V/50HZ	31301	31302
2	FILTER DRIER	7896	
3	FAN MOTOR 220V/50HZ	2170	
4	FAN BLADE	587	
5	AIR CONDENSER	31690	
6	FAN CONTROL PRESSURE SWITCH	31160E	
7	HIGH PRESSURE SWITCH	31660E	
8	PRESSURE SWITCH COLLECTOR	31444	
9	HOT GAS VALVE - COIL 220V/50HZ	6906	
10	HOT GAS VALVE - BODY	6904	
11	CLIP TUBE	337	

WATER CONDENSER UNIT

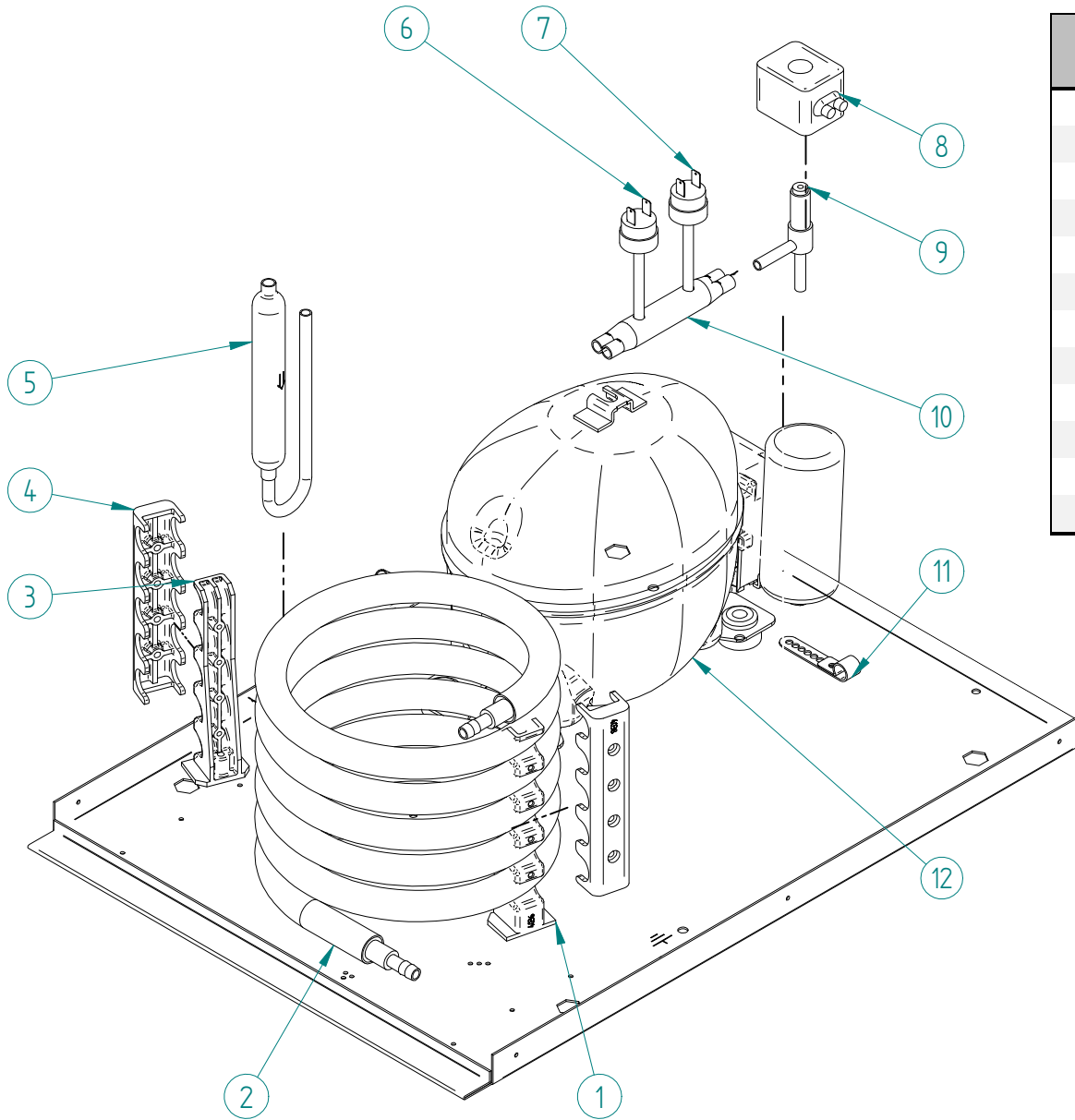

ITEM	DESCRIPTION	CODE	
		20-30	40
1	WATER CONDENSER UPPER SUPPORT		4036
2	WATER CONDENSER		8483
3	WATER CONDENSER LOWER SUPPORT		4037
4	WATER CONDENSER EXTERNAL SUPPORT		4038
5	FILTER DRIER		7896
6	FAN CONTROL PRESSURE SWITCH		31160E
7	HIGH PRESSURE SWITCH		31660E
8	HOT GAS VALVE - COIL	220V/50HZ	6906
9	HOT GAS VALVE - BODY		6904
10	PRESSURE SWITCH COLLECTOR		31444
11	CLIP TUBE		337
12	COMPRESSOR	220V/50HZ	31301 33302

ELECTRIC PARTS

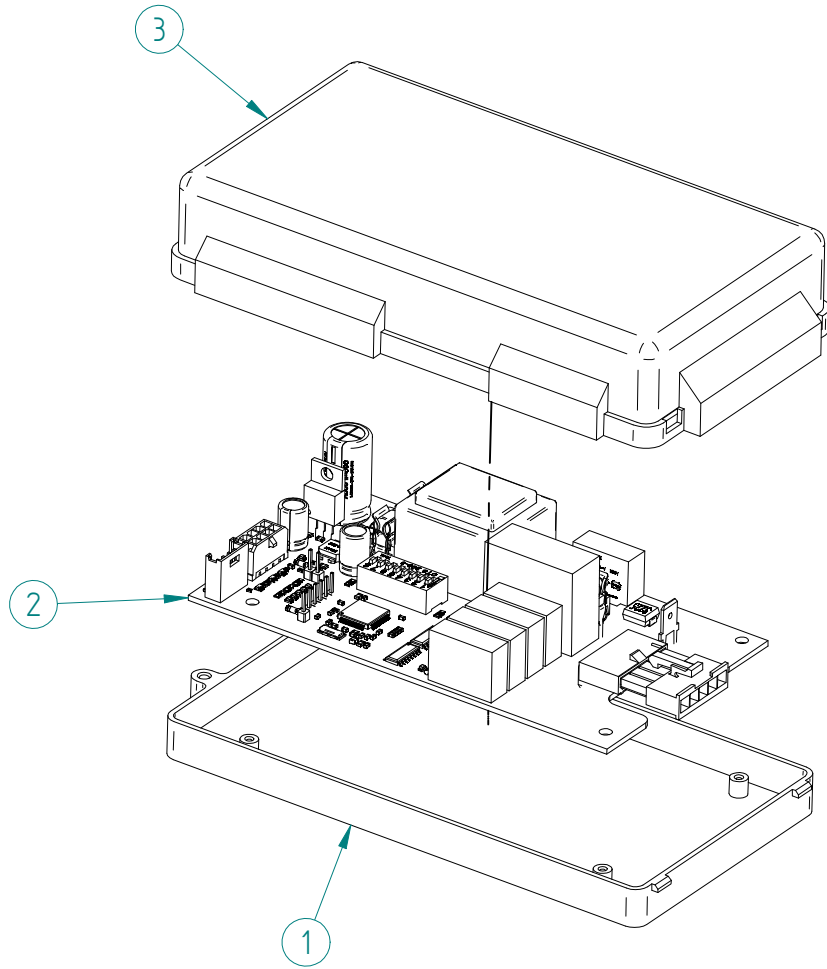

ITEM	DESCRIPTION	CODE
		20-30-40
1	ELECTRIC BOX	2181
2	ELECTRONIC BOARD 220V/50HZ	32715
3	ELECTRIC BOX COVER	30861
4	CLEANING SWITCH	31719
5	MAIN SWITCH	32416
6	LED	32415
7	INLET WATER VALVE SIMPLE 220V/50HZ	329
	INLET WATER VALVE DOUBLE 220V/50HZ	404

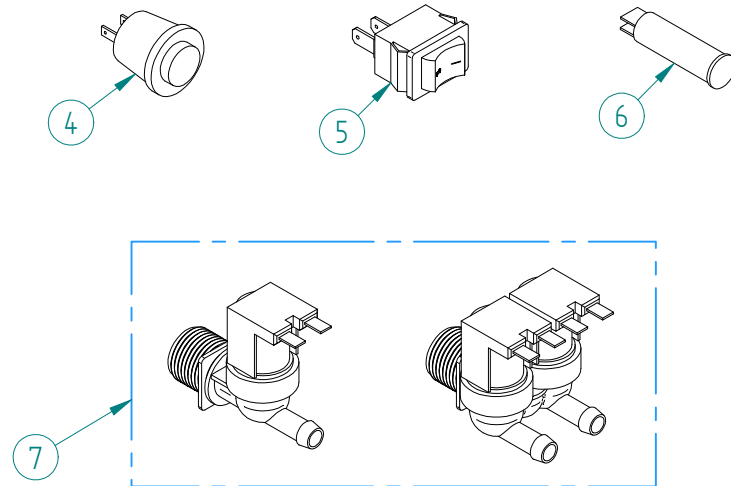

BIN & CABINET

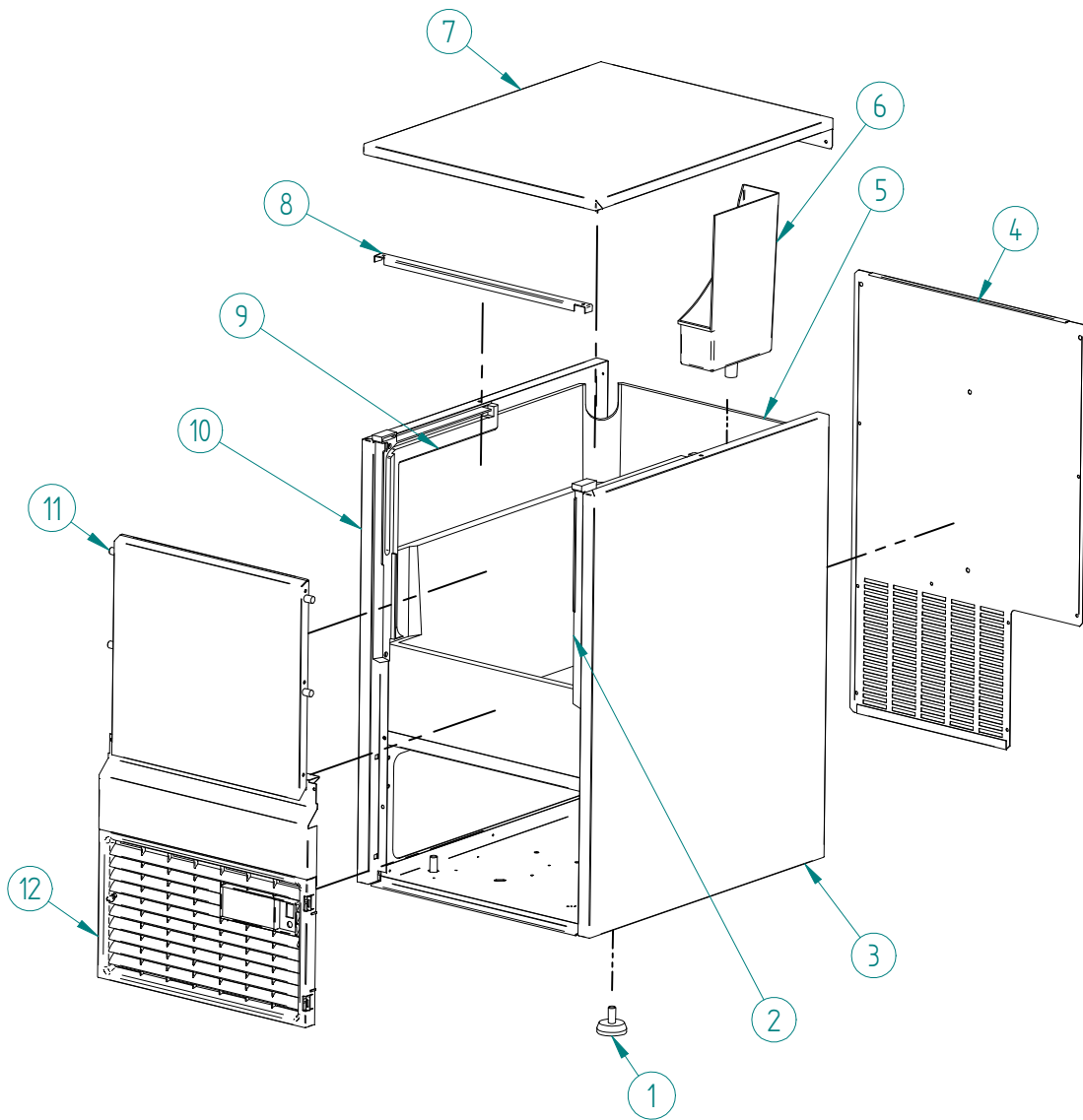

ITEM	DESCRIPTION	CODE	
		20	30-40
1	LEGS	2171	
2	RIGHT DOOR GUIDE	1700	
3	RIGHT PANEL	8057	8059
4	REAR COVER	8063	8064
5	BIN	7510	8413
6	DRAIN BIN	593	
7	TOP PANEL	8056	
8	UPPER REINFORCEMENT	8217	
9	LEFT DOOR GUIDE	1701	
10	LEFT PANEL	8058	8060
11	DOOR	8204	
12	FRONT LOUVER	7885	

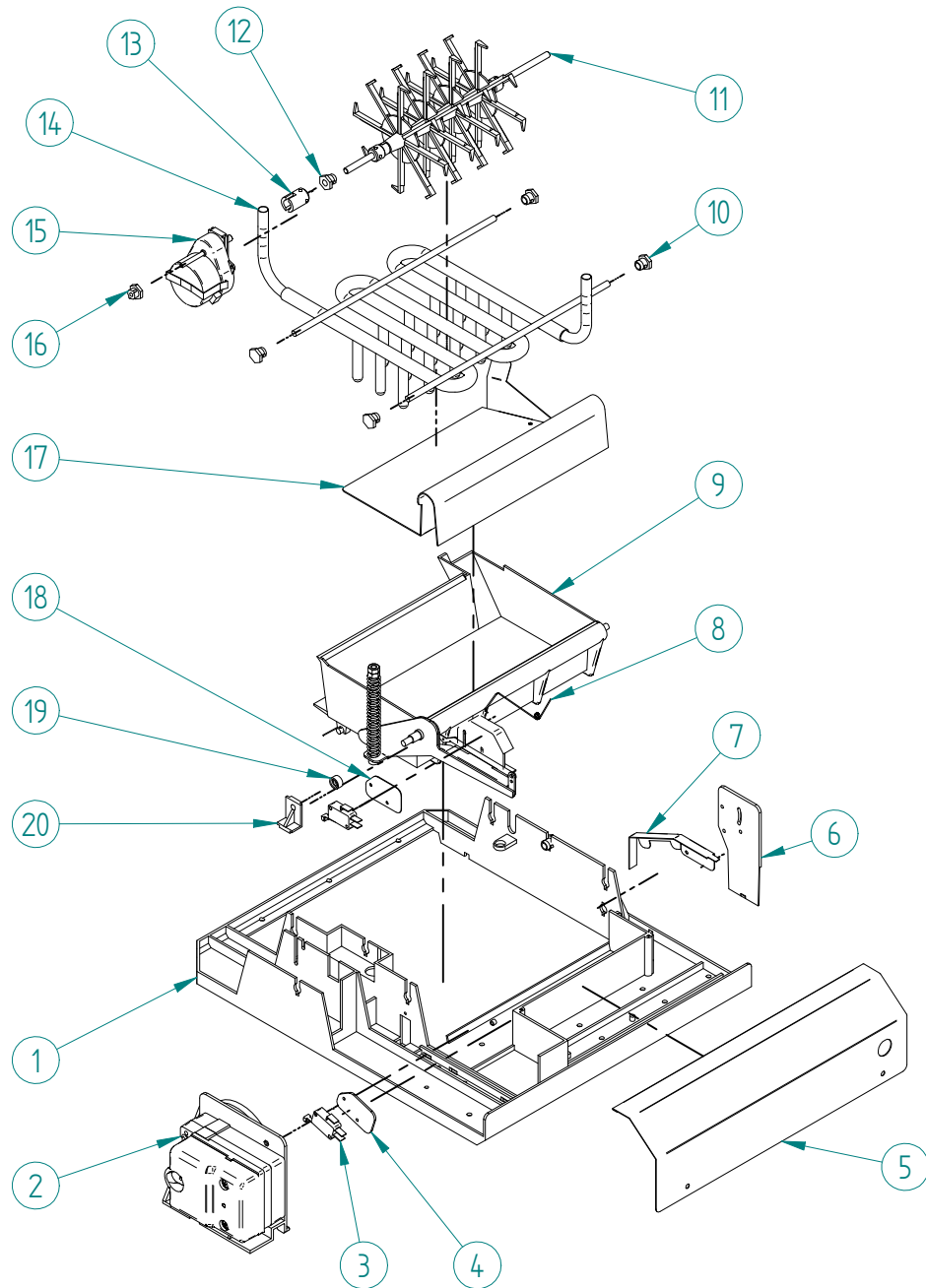

ITEM	DESCRIPTION	CODE	
		20	30-40
1	HYDRAULIC BASEMENT	175	
2	MOTOR ASSEMBLY WITH MICRO	8071U	
3	MICRO PROTECTION	5212	
4	MICRO SWITCH	32998	
5	FRONT COVER	32973	
6	WATER LEVEL SENSOR SUPPORT	595	
7	WATER LEVEL SENSOR	32971	
8	STOP SPRING	31508	
9	WATER TRAY ASSEMBLY	5360U	5361U
10	EVAPORATOR SUPPORT	564	
11	PADDLE	8074	
12	PADDLE BEARING	556	
13	PADDLE MOTOR COUPLING BUSH	46	
14	EVAPORATOR	7984	7989
15	PADDLE MOTOR	5364	
16	EXTERNAL PADDLE BEARING	554	
17	ICE CUBE RAMP	5537	5532
18	MICRO PROTECTION	5211	
19	WATER TRAY SUPPLEMENT	674	
20	TRAY AXIS SUPPORT	558	