

03/2021

Mod: PTH-S1/T

Production code: 6.0.145.0008

SEMIAUTOMATIC FILTER COFFEE BREWER**SEMIAUTOMATIC FILTER COFFEE BREWER****FOR THERMOS PTH-S1/T – 6.0.145.0008**

POWER	1739-2069W
POWER SUPPLY	220-240V~, 50/60Hz
NET WEIGHT	8.4Kg
DIMENSIONS (LxWxH)	196x360x563mm
PACKAGE DIMENSIONS (LxWxH)	260x470x630mm
OBS	INCLUDES 1 THERMO (2,2 Lts)

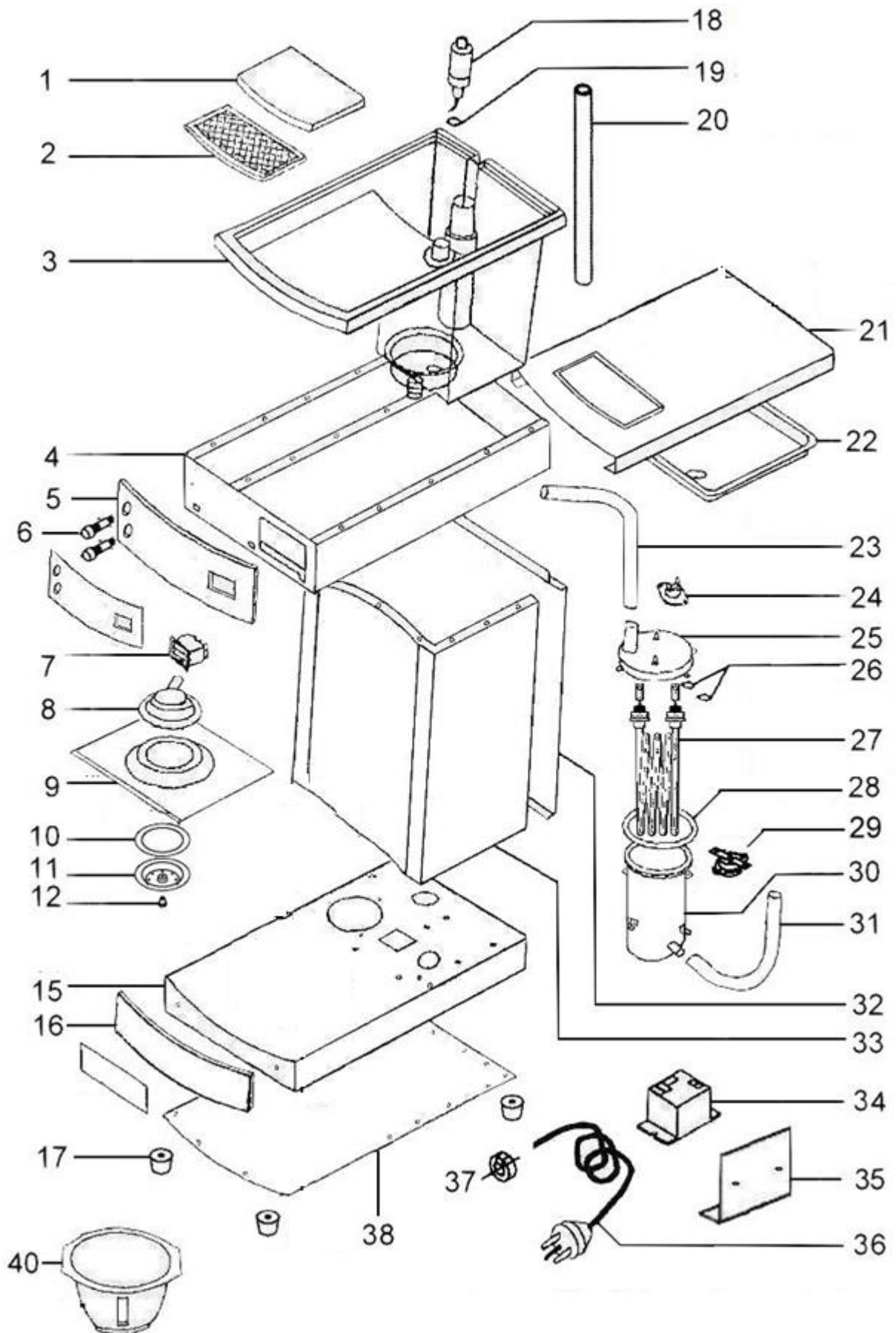

N°	DESIGNATION	ARTICLE N°
1	LID OF RESERVOIR	5.0.145.0050
2	GRILL RESERVOIR	5.0.145.0051
3	RESERVOIR	5.0.145.0052
4	UPPER FRAME	
5	INDICATE PANEL	
6	* INDICATION LAMP GEEN	5.0.145.0042
6	* INDICATION LAMP RED	5.0.145.0023
7	* POWER SWITCH TWIN	5.0.145.0053
8	SPRINKLER	5.0.145.0034
9	SPRINKLER COVER	
10	* SEALING WASHER OF SPRINKLER	5.0.145.0055
11	SPRINKLER DISTRIBUTOR	5.0.145.0056
15	BASE FRAME	
16	LOWER PANEL	
17	BOTTOM HEEL	
18	* FLOAT SWITCH	5.0.145.0049
19	SEALING WASHER OF FLOAT	5.0.145.0057
20	SPILLWAY TUBE (RESERVOIR)	5.0.145.0058
21	UPPER COVER	
22	MIST PARTITION	
23	SILICON PIPE WATER IN	5.0.145.0059
24	* THERMOSTAT	5.0.145.0020
25	LID BOILER	
26	SEALING WASHER OF HEATER	5.0.145.0060
27	* HEATING ELEMENT	5.0.145.0025
28	SEALING WASHER OF BOILER	5.0.145.0037
29	* MANUAL RESET THERMOSTAT	5.0.145.0021
30	BOILER TANK	
31	SILICON PIPE WATER OUT	5.0.145.0036
32	REAR FRAME	
33	BODY FRAME	
34	* RELAY	5.0.145.0037
35	RELAY HOLDER	
36	POWER CABLE + CORD	
37	POWER CABLE PROTECTOR	
38	BOTTOM COVER	
40	S/S FILTER PAN	5.0.145.0026