

01/2019

# Mod: **SLID-14-R2**

**Production code: 06.02.0.BR.50.2.F.230.50 (430 CHV/VCI)**



**Diamond**  
catering equipment

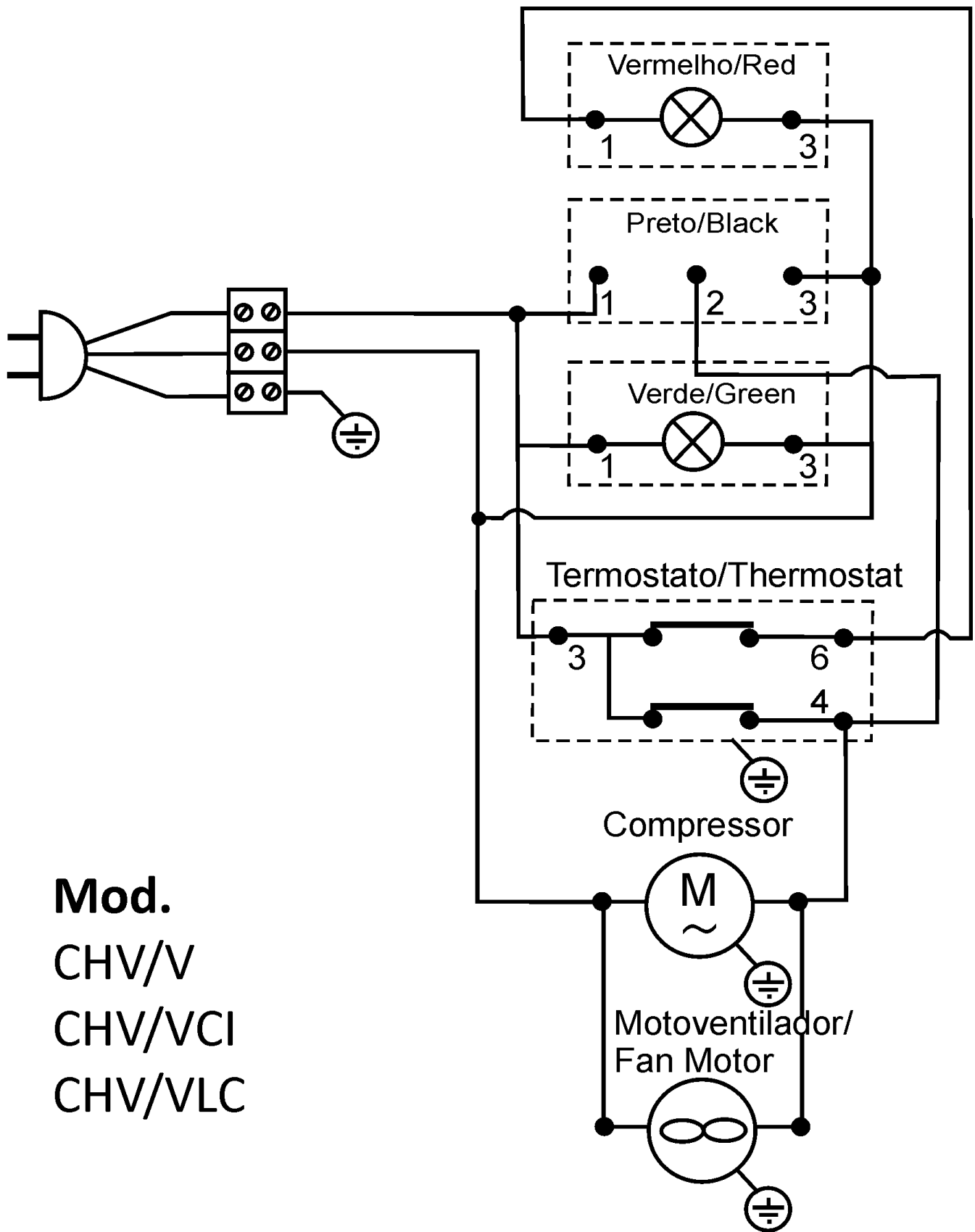

**Mod.**

CHV/V

CHV/VCI

CHV/VLC