

01/2018

Mod: **SLD8/35-N**

Production code: **P11SP20013**



Diamond
catering equipment

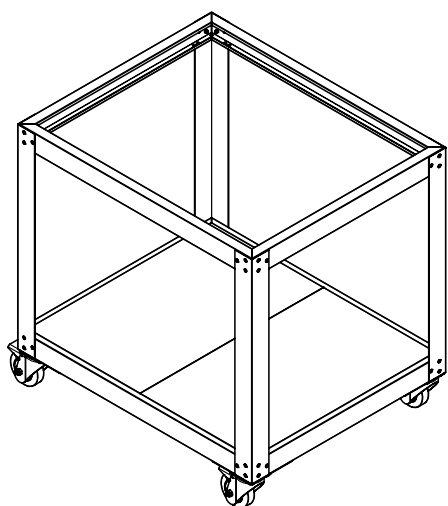
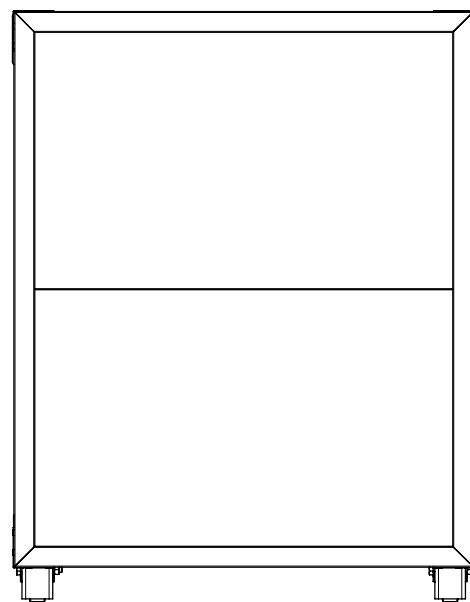
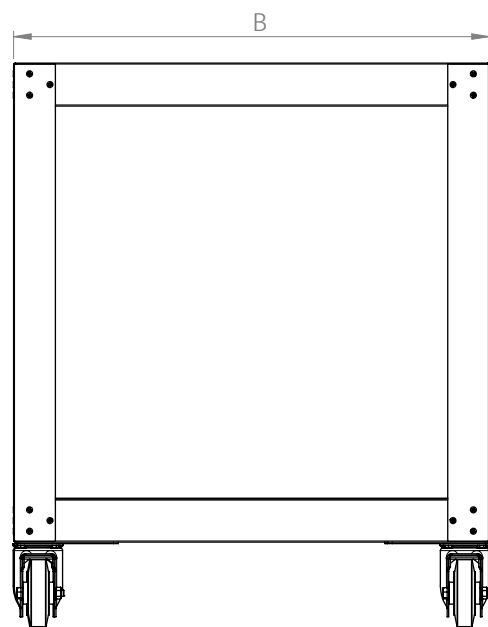
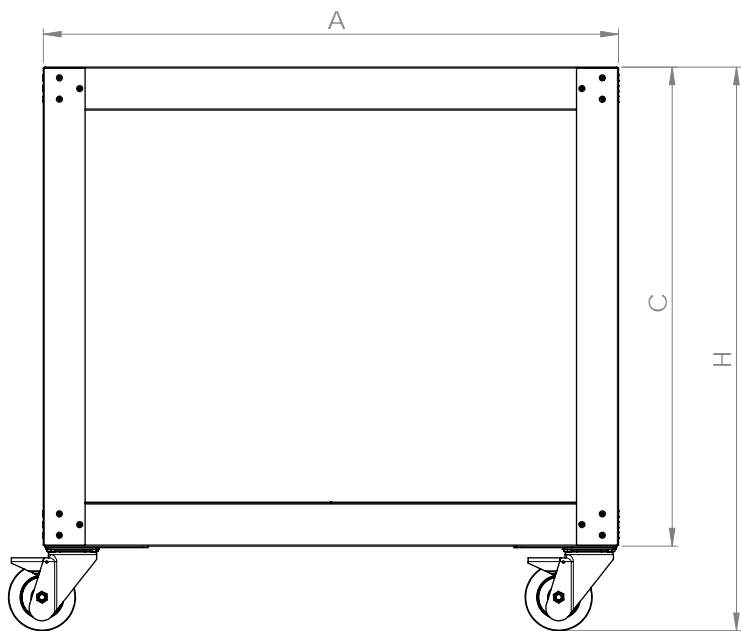

INGOMBRI SUPPORTI FORNI LOGIC PLUS LINE

MOD. FORNO	COD. SUPPORTO	A	B	C	H	Peso netto (Kg)
		(mm)	(mm)	(mm)	(mm)	
4	P11SP20009	1073	888	894	1049	34
6	P11SP20010	1073	1238	894	1049	44
6L	P11SP20011	1422	888	894	1049	44
9	P11SP20012	1422	1238	894	1049	50
8	P11SP20013	1073	888	694	849	35
12	P11SP20014	1073	1238	694	849	42
12L	P11SP20015	1422	888	694	849	42
18	P11SP20016	1422	1238	694	849	48