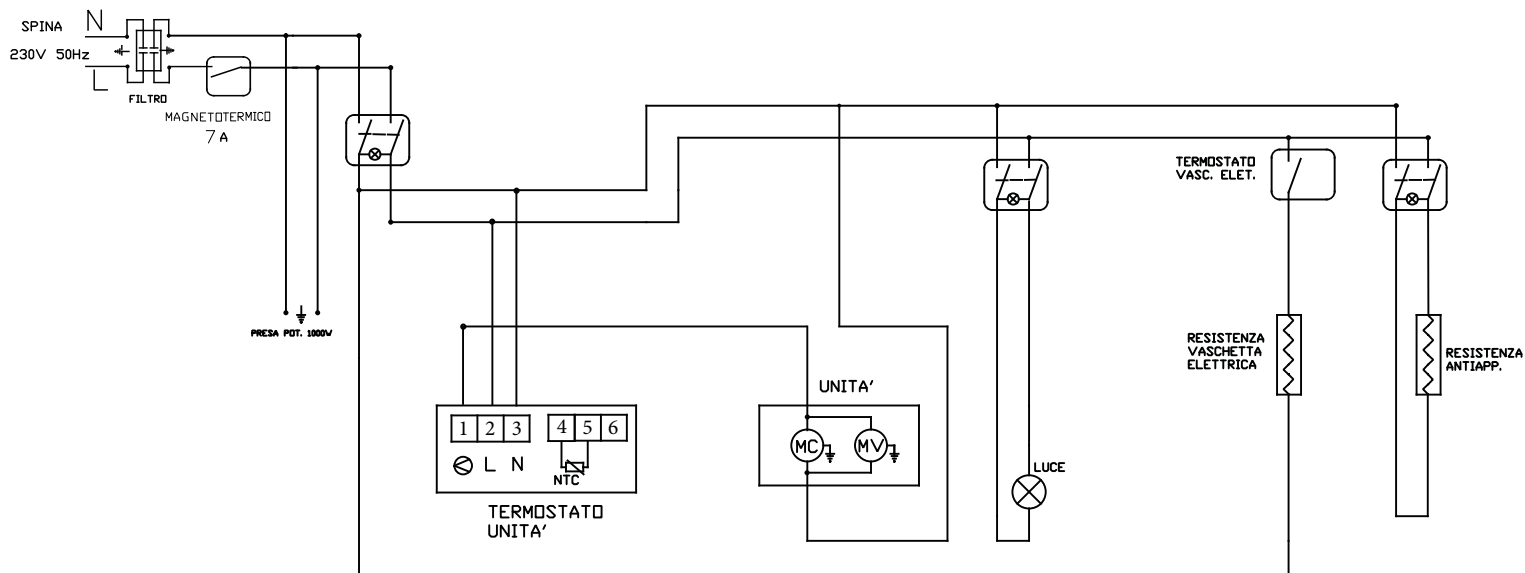

08/2021

Mod: R010/B5-R2

Production code: TB100PSSND97H

LEGENDA:

**MAGNETOTERMICO - MAGNETOTHERMISCHER SCHALTER - MAGNETOTHERMAL SWITCH -
 INTERRUPTEUR MAGNETOTHERMIQUE - INTERRUPTOR MAGNETOTERMICO**

SPINA: STECKER - PLUG - FICHE - ENCHUFE

UNITA': AGGREGAT - UNIT- GROUPE COMPRESSEUR - GRUPO COMPRESOR

**TERMOSTATO UNITA': THERMOSTAT AGGREGAT - THERMOSTAT UNIT - THERMOSTAT GROUPE COMPRESSEUR -
 THERMOSTATO GRUPO COMPRESOR**

**TERMOSTATO VASC.ELETR.: REGLER DER VERDUNSTUNGSSCHALE - CONTROLLER OF THE EVAPORATING PAN -
 THERMOSTAT DU BAC D'EVAPORATION - THERMOSTATO CUBETA DE EVAPORACION**

LUCE: BELEUCHTUNG - LIGHTING - ECLAIRAGE - ILUMINACION

**VENTILATORE EVAP.: VERDAMPFER VENTILATOR - EVAPORATOR FAN - VENTILATEUR DE L'EVAPORATEUR - VENTILADOR
 DEL EVAPORATOR**

FILTRO.: FILTER - FILTER - FILTRE - FILTROFI

ACCESSORI - ZUBEHOERTEILE - OPTIONALS - ACCESSOIRES - ACCESORIOS

PRESA POT. 1000W.: STECKDOSE 1000W - SOCKET 1000W - PRISE 1000W - TOMA 1000W

**RESISTENZA VASCETTA ELETTRICA.: VERDONSTERSCHALE-HEIZUNG - EVAPORATING PAN HEATER - RESISTANCE DU BAC
 D'EVAPORATION - RESISTENCIA DE LA CUBETA DE EVAPORACION**

**RESISTENZA ANTIAPPANNAMENTO.: ANTI-BESCHLAGHEIZUNG - ANTI-MIST HEATER - RESISTANCE ANTIBUEE - RESISTENCIA
 ANTIVAHO**

03	3°EMISSIONE	10/07/19
02	2°EMISSIONE	10/04/18
01	1°EMISSIONE	19/01/10
REV.	DESCRIZIONE	DATA

FIRMA APPR.	MOD.	TOLLERANZA +/-2mm
-------------	------	----------------------

SCHEMA ELETTRICO BANCHI STATICI CON RESISTENZA ANTIAPP. CON EVAPORAZIONE ELETT.

CON □ SENZA PRESA