

08/2021

Mod: ML10/B5-VV/R2

Production code:PY104PSCND97H

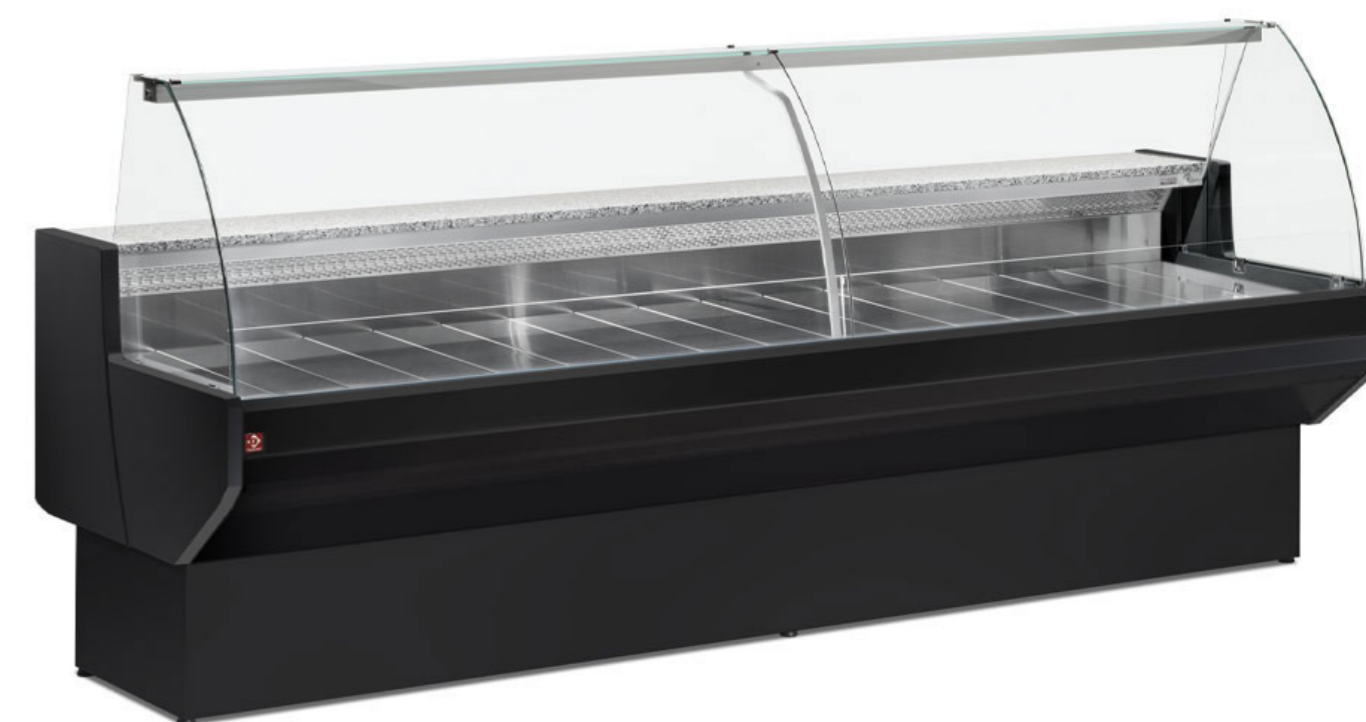
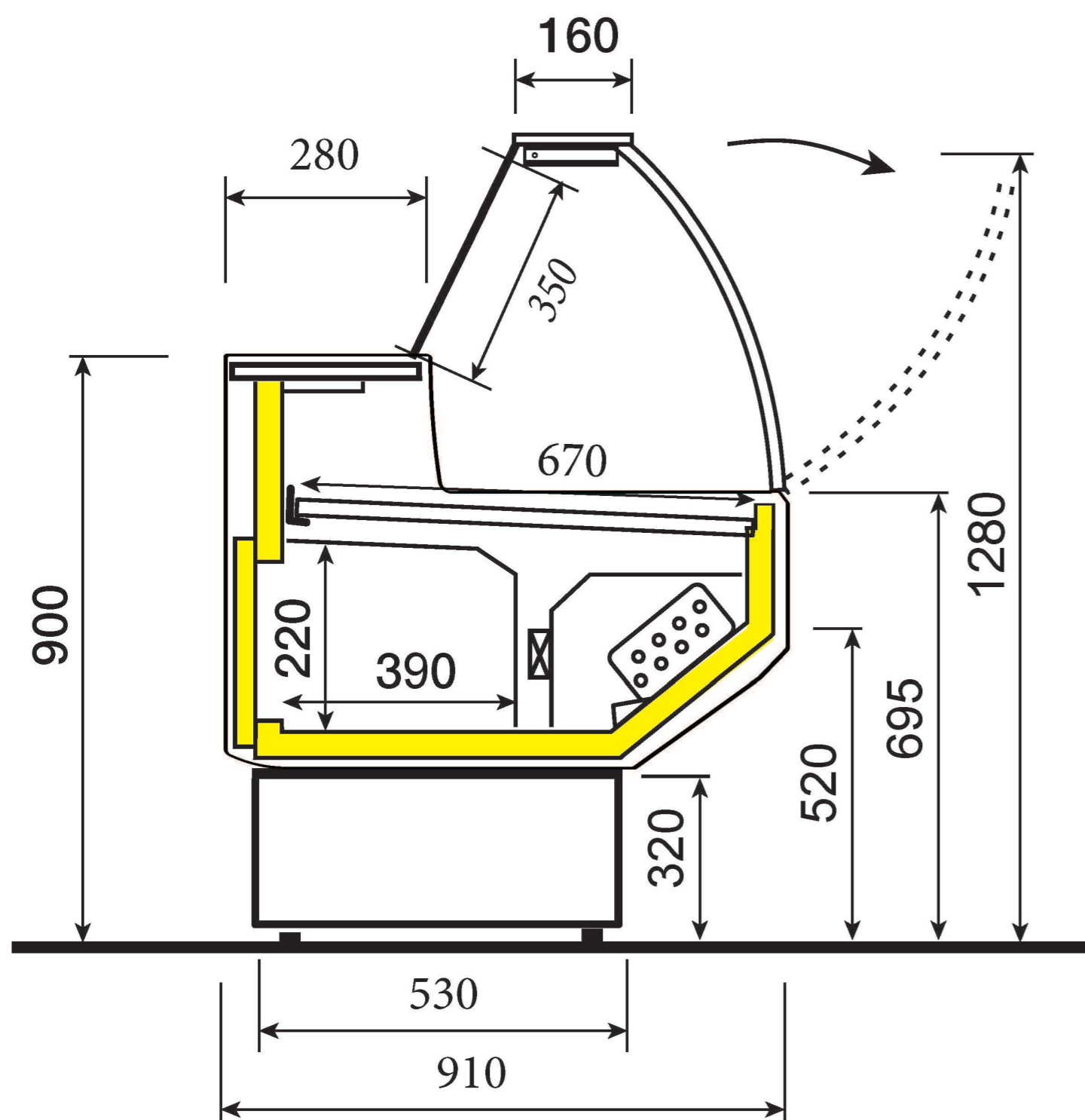

MODELLO	LUNG. LENGTH LAENGE LONGUEUR	MOTORE COMPRESSOR KOMPRESSOR COMPRESSEUR	ILLUMINAZIONE LIGHTING BELEUCHTUNG ILLUMINATION	QUANTITA' GAS GAS QUANTITY GAS MENGE QUANTITE' DE GAS (KG.)	TIPO DI GAS KIND OF GAS GAS-TYP TIPE DE GAZ	HP	Potenza frigorifera Refrigeration power Kalteleistung Puissance frigorifique Watt (-10°C)	Watt assorbiti Watt absorbed Nennleistungsaufnahme Watts absorbés 220 V	Assorbimento Ventilatori Vasca Fab absorption Luefteraufnahmen Absorption ventilateurs (W)
	VENTILATO - UMLUFT - AIRY - VENTILE - VENTILADA								
PATAGONIA	104	<i>NUY70RAa</i>	<i>1 x 7w</i>	<i>0,105</i>	<i>R 290</i>	<i>1/3+ HP</i>	<i>523</i>	<i>286</i>	<i>19</i>
	150	<i>NUY90RAa</i>	<i>1 x 13w</i>	<i>0,100</i>	<i>R 290</i>	<i>1/2 HP</i>	<i>666</i>	<i>378</i>	<i>19</i>
	200	<i>NPY12RAa</i>	<i>1 x 16w</i>	<i>0,150</i>	<i>R 290</i>	<i>1/2+ HP</i>	<i>804</i>	<i>583</i>	<i>38</i>
	250	<i>NPT14RA</i>	<i>2 x 10w</i>	<i>0,147</i>	<i>R 290</i>	<i>3/4+ HP</i>	<i>955</i>	<i>599</i>	<i>38</i>
	300	<i>NX21TBa</i>	<i>2 x 13w</i>	<i>0,150</i>	<i>R 290</i>	<i>1- HP</i>	<i>1441</i>	<i>837</i>	<i>38</i>

Modello: MOLINA Revisione: 00

Codice: PT

Data:
17-11-2020

I dati tecnici possono essere soggetti a cambiamenti senza alcun obbligo di preavviso. We reserve the right to change technical features without notice. Technische aenderungen sind ohne voranzeige moeglich. Nous nous reservons le droit de varier sans preavis les details techniques.