

08/2021

Mod: GL6/35-D

Production code: GR635/1D

Installation

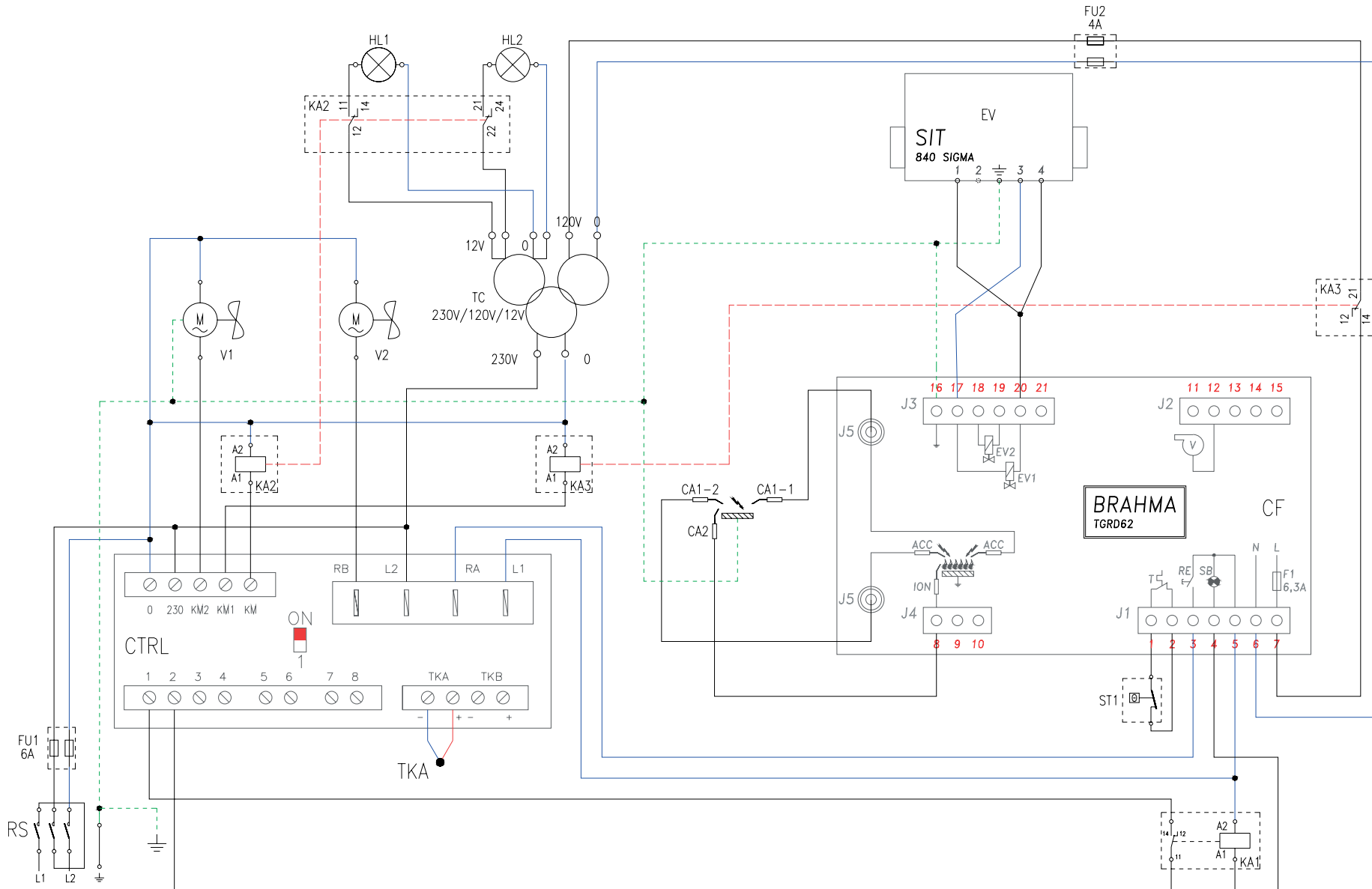

Abbreviation	Description
TC	Light transformer 230/120Vac/12Vca
FU	Fuses
HL1-2	Lighting lamps
ST1	Safety thermostat

Abbreviation	Description
CA1-x	Ignition glow plug
CA2	Ionization glow plug
RS	Disconnecter switch
V1	Gas chamber suction fan
V2	Suction fan for wiring compartments

Abbreviation	Description
KA1	Burner alarm control relay
KA2	Light control relay
KA3	Solenoid valve control relay
CF	Burner control board
CTRL	Oven control board
EV	Solenoid valve

Installation

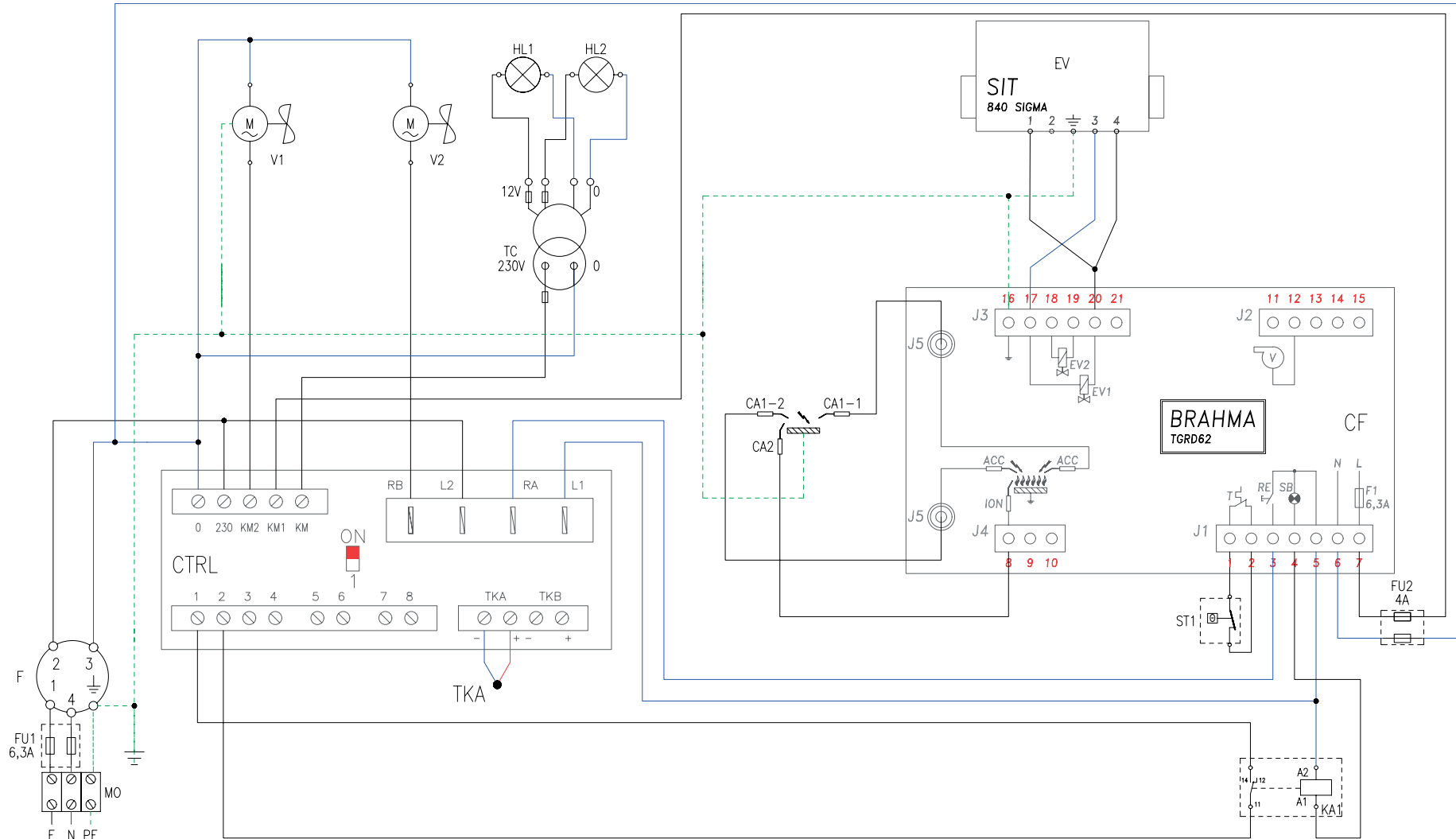

Abbreviation	Description
TC1	Light transformer 230/12Vca
FU	Fuses
HL1-2	Lighting lamps
ST1	Safety thermostat

Abbreviation	Description
CA1-x	Ignition glow plug
CA2	Ionization glow plug
MO	Line terminal board
V1	Gas chamber suction fan
V2	Suction fan for wiring compartments

Abbreviation	Description
KA1	Burner alarm control relay
CF	Burner control board
CTRL	Oven control board
EV	Solenoid valve
F	Noise filter