

08/2021

Mod: GL4/35-D

Production code: GR435/1D

We congratulate you for choosing a product designed and manufactured with cutting-edge technology.

The oven is checked and tested in the Manufacturer's plant before being delivered to the customer.

The "production process check sheet" enclosed with it guarantees that **each** step in the production process, from assembly to packaging, was carefully checked from both the operating and safety standpoints.

Before the installation, read the content of this manual **carefully**: it contains important information regarding product assembly and safety regulations.

The foundation

Our company was founded in 1963 by the Lorenzo, Luigi and Paolo Cuppone brothers. It immediately specialized in the production of ovens and equipment to prepare and cook pizza.

The constant research and experimentation of new equipment that are even now the strength of our company, have led us to design and patent the machinery and ovens that have revolutionized the way pizza is made.

Technical service

Your Dealer can solve any technical problem regarding use and maintenance.

Do not hesitate to contact him in case of doubt.

CUPPONE 1963
Cuppone F.lli S.r.l.
Via Sile, 36
31057 Silea (TV) - ITALY
T +39 0422 361143
F +39 0422 360993
info@cuppone.com - www.cuppone.com

Introduction	3
Technical service.....	3
Safety instructions	4
Basic notions	6
Knowing your oven	6
Preparing to use the oven	6
Some piece of advice.....	7
Unsatisfactory cooking results.....	7
Cooking tables.....	8
Use	9
Knowing the control panel.....	9
Using the models.....	10
Use guided procedure.....	10
A - Turning the oven on.....	10
B - Setting the preheating.....	10
C - Starting cooking	10
D - Switching the light on (optional)	10
E - Activating an end-of-cooking signal (buzzer)	11
F - Switching the oven off	11
Maintenance and cleaning	12
Warnings.....	12
Oven cleaning.....	12
Cleaning the external steel parts	12
Cleaning the glass	12
Cleaning the refractory surface.....	12
Cleaning the chamber with the pyrolysis function	13
Replacing components	14
Replacing the door glass.....	14
Door external heat-protection glass replacement.....	14
Replacing the internal bulb and glass	15
Replacing the refractory bricks.....	15
Oven downtime for prolonged periods	16
Disposal at end of life	16
Disposing of ashes and food residues	16
Warranty	17
Warranty conditions	17
Something is not working	18
What to do in case of any malfunction	18

Safety instructions



- Read this guide carefully before using and maintaining the appliance, and keep it with care in an accessible place for any future consultation by the various operators.
- Moreover, the manual must always accompany the product through its life, even in case of transfer.
- Before performing any maintenance, replacing components or carrying out any routine/extraordinary cleaning, disconnect the electricity supply.
- Unauthorised actions, tampering or modifications that do not follow the information provided in this manual can cause damages, injuries or fatal accidents and null and void the warranty.
- Use or maintenance that fail to comply with the instructions in this manual may cause damage, injury or fatal accidents.
- The serial plate provides important technical information. This is vital in case of a request for maintenance or repair of the equipment: please do not remove, damage or modify it.
- Some parts of the equipment can reach high temperatures. We advise you to avoid touching surfaces and not to get materials either flammable or sensitive to heat near the appliance.
- Do not rest objects on the oven or flue, above all if built in heat sensitive material.
- These appliances are intended to be used for commercial applications, for example in restaurant kitchens, canteens, hospitals and commercial companies such as bakeries, butcher shops, etc., but not for the continuous and mass production of food. A use other than the stated one is considered improper, potentially dangerous for people and animals and might permanently damage the appliance. The improper use of the equipment shall void the warranty.
- This appliance can be used by children aged from 8 years and above and persons with reduced physical, sensory or mental capabilities or lack of experience and knowledge if they have been given supervision or instruction concerning the use of the appliance in a safe way and understand the hazard involved. Children must not play with the appliance. Cleaning and user maintenance shall not be made by children without supervision.
- To clean the appliance, any of its components or accessories and the sub-structure DO NOT use:
 - aggressive, abrasive, powder or corrosive detergents (e.g. hydrochloric or sulphuric acid, caustic soda, etc.).
 - abrasive or sharp tools (e.g. abrasive sponges, scrapers, steel brushes, etc.);
 - steamed or pressurised water jets.
- The staff using the appliance must be professionally prepared and periodically trained on its use, as well as the safety and accident prevention regulations.
- Children must be supervised to make sure they do not play with the appliance or parts of it.
- Always use tools resistant to heat (e.g. In steel). Cooking utensils in plastic or similar material might not withstand the oven high temperatures.
- Check regularly that fumes can be discharged safely. Do not obstruct the duct for any reason.
- FIRE RISK: leave the area around the appliance free and clean from fuels. Do not store flammable materials near this appliance.
- ATTENTION - To reduce the risk of fire, the appliance must be installed only in environments that meet the safety requirements of the current regulations and the gas company. Such environments must have adequate and constant ventilation. Make sure that there is a continuous exchange of air from the outside to ensure proper combustion and to prevent the formation of volatile substances harmful to health (danger of suffocation!). The installation environments must be NON-combustible, without combustible materials within about 46 cm (18 inches) from the sides, front or rear of the appliance or within about 102 cm (40 inches) above the appliance. The appliance must be mounted on floors of non-combustible structures with non-combustible floors and surface finishes and without combustible materials in contact with the lower side, or on non-combustible plates or arches without combustible material in contact with the lower side. This structure must in any case extend no less than about 31 cm (12 inches) beyond the equipment on all sides.
- WARNING: always switch off the main switch when you finish using the appliance, above

all during cleaning or in cases of prolonged downtime.

- If you notice any anomaly (e.g. damaged power cable, etc.), malfunction or fault, do not use the appliance and contact a Service Centre authorized by the Manufacturer. Demand original spare parts, or the Warranty will be null and void.
- Place the emergency phone numbers in a visible location.
- **WARNING:** it is forbidden to place flammable solids or liquids (spirits for instance) in the cooking chamber during the operation.
- Monitor the appliance during its entire operation, do not leave dishes in the oven unattended!
- Failure to follow these regulations may cause damage or even fatal injury, subsequently invalidating the guarantee and relieving the Manufacturer of all liability.
- We recommend you have the appliance checked by an Authorized Service Centre at least once a year.
- Before performing any ordinary cleaning, disconnect the electricity and gas supplies.

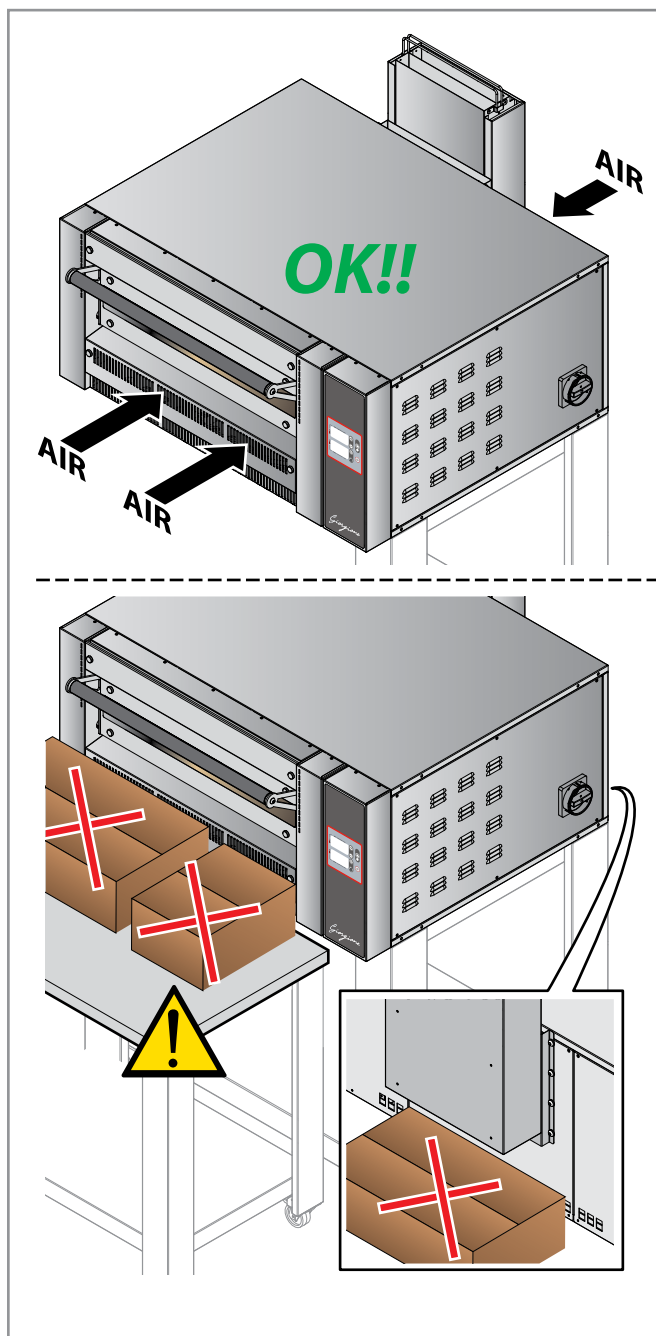

Symbols used in the manual and on the labels applied to the machine



Indicates that caution is required when performing an operation described in a paragraph that bears this symbol. The symbol also indicates that maximum operator awareness is required in order to avoid unwanted or dangerous consequences



Reference to another chapter where the subject is dealt with in more detail.



Manufacturer's tip



Indicates that the surfaces marked with this symbol may be hot and must therefore be touched carefully



Dangerous voltage



The symbol identifies the terminals which, connected to each other, carry the various parts of a device or system to the same potential (not necessarily the earth potential)



Indicates that it is necessary to read carefully the paragraph marked with this symbol before installing, using and maintaining the equipment

The company cannot be held liable for any print or transcription errors, reserving the right to make changes where deemed suitable without prior notice.

Partial reproduction without the Manufacturer's consent is prohibited. Measurements are purely indicative and not binding.

The original language used to prepare this manual is English: the Manufacturer is not responsible for any translation/interpretation or print errors.

Knowing your oven

► Fig. 1

Your oven can be used only to bake pizzas or similar dishes, such as bread or focaccia and to grill vegetables.

Its main parts are:

- A Control panel
- B Air intakes (**do not cover**)
- C Mobile inspection bench (burner adjustments)
- D Oven door
- E Door external heat-protection glass
- F Removable heat protection
- G Oven smoke and burnt gas discharge
- H Fall protection
- I Access panel for electrical components
- L Circuit breaker (only USA models)

The temperature in the chamber is controlled by a board that switches the burner on and off to keep the set temperature constant.

Preparing to use the oven

Clean the oven and any accessories accurately, both externally and internally, following the instructions in the dedicated chapter rigorously.

 **Maintenance and cleaning** - page 12.

The first time you use the oven, we recommend you set the temperature at **150°C - 302 °F**, for at least **8 hours, without placing any food inside**. If the oven is fitted under a hood (not supplied), we recommend you keep it switched on. In this first phase, because of the humidity evaporating from the insulating materials, the oven will give out unpleasant smells and fumes that will gradually disappear during the following operating cycles.

To switch the oven on and set its parameters, see page [10](#).

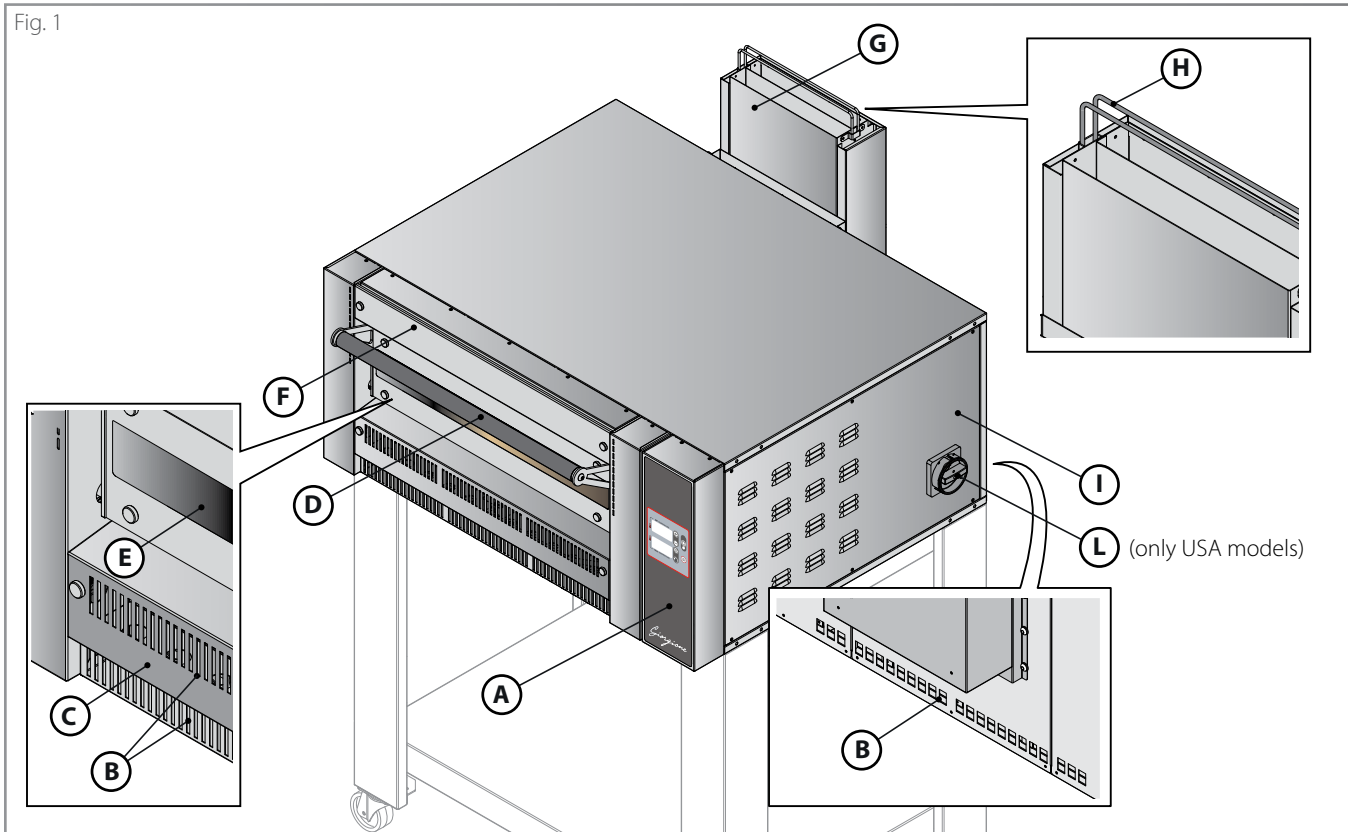

 *The first day of use is considered as a running-in period: during this time the refractory bricks and insulating material keep releasing humidity until they dry out completely.*

 **Some parts of the equipment can reach high temperatures.**
We advise you to avoid touching surfaces and not to get materials either flammable or sensitive to heat near the appliance.

Do not rest objects on the oven and especially on flue, above all if built in heat sensitive material.

Do not cover the front vents with any objects.

Take care and use personal protection equipment (i.e. gloves) when putting food into the cooking chamber or getting it out.

Some piece of advice...

- Before starting cooking, always preheat the oven: this is vital to get good food. Pre-heating the oven **must last about an hour**.
- During work, keep the refractory surfaces clean using a stiff bristle brush.
- Passing from a type of pizza to another, wait for the oven to stabilize.
- An excess of flour in the cooking chamber can create smoke, smell and give the pizza an unpleasant taste.
- Clean the oven at the end of service.

► Fig. 2

In the ovens, products cook thanks to the combined action of:

- **radiation:** the heat coming from the burner is conveyed by special deflectors placed on the sides of the cooking chamber. The heat flow radiates the product to be cooked making it well cooked and golden;
- **convection:** the hot air that circulates in the chamber cooks the product evenly;
- **conduction:** the heat from the burner heats the refractory surfaces on which the products rest.

Unsatisfactory cooking results

If the cooking results are not as expected, try and check the following:

- **temperature in the chamber** either too high or too low
- **incorrect preheating:**
 - preheating is vital to get superb results right from the first pizza;
 - during preheating, the temperature has been set too high: the refractory surfaces (without pizzas) have become too hot and burnt the first pizzas.



What is Pizzaform?

Pizzaform is a Manufacturer's patent. It is a special press, produced in five models, to make pizza dough discs up to Ø52 mm [Ø20.47 in.].

Its main features are:

- *high hourly output, up to 400 pizzas an hour, without using specialized labour;*
- *consistent shape and thickness of the disc of dough, without giving up the traditional edge, obtained thanks to the special shape of the chrome plates;*
- *possibility of changing the thickness of the dough discs easily.*



Fig. 2

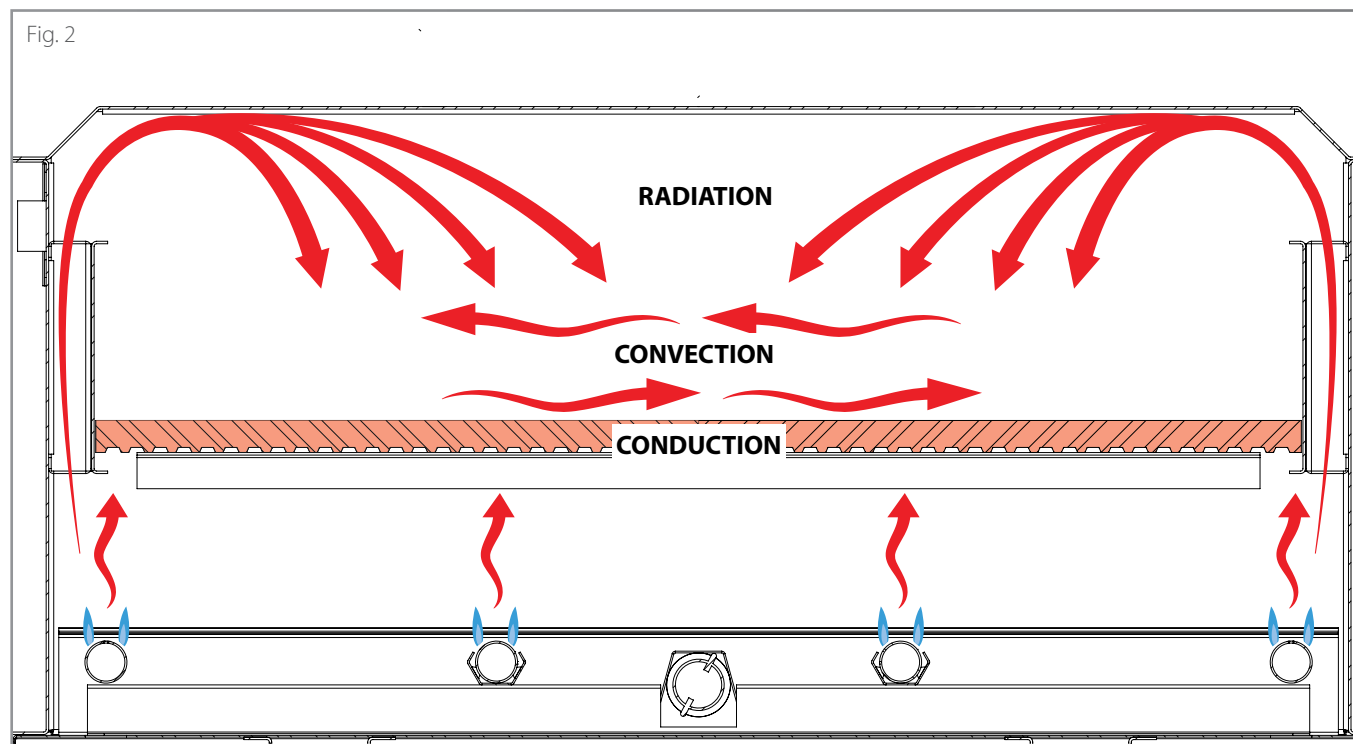

Basic notions

Cooking tables

The parameters in the tables are just indicative, since they can vary according to the type of dough to bake (e.g. type of flour, hydration, etc.).

		 Manual stretching				 Stretching with Pizzaform			
TYPE	PREHEATING		COOKING		PREHEATING		COOKING		
	TIME	TEMP.	TIME	TEMP.	TIME	TEMP.	TIME	TEMP.	
CLASSIC	1 hour	330°C - 340°C 626°F - 644°F	3.5 min	330°C - 340°C 626°F - 644°F	1 hour	320°C - 608°F	3.5 min	320°C - 608°F	
NEAPOLITAN	1 hour	300°C - 572°F	2 min	370°C - 698°F		/		/	
DIRECT PADDLE	1 hour	300°C - 572°F	4-5 min	300°C - 572°F		/		/	
PADDLE	PRECOOKING	1 hour	270°C - 518°F	5 min	270°C - 518°F		/	/	
	FINISHING	1 hour	270°C - 518°F	3 min	270°C - 518°F		/	/	

Table of contents

Knowing the control panel.....	9
Use guided procedure.....	10
A - Turning the oven on.....	10
B - Setting the preheating.....	10
C - Starting cooking.....	10
D - Switching the light on (optional).....	10
E - Activating an end-of-cooking signal (buzzer)	11
F - Switching the oven off	11

Knowing the control panel

► Fig. 3

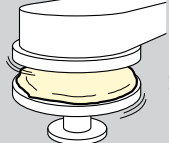
- 1 **Top display**
Displays the temperature set or to be set or the time set or to be set of an acoustic signal at the end of cooking (buzzer)
- 2 **Bottom display**
Displays the actual temperature in the chamber
- 2a **Led**
Shows the status of the burner:
 - led on: burner active
 - led off: burner NOT active
- 3a **+ key**
Increases the value to set
- 3b **- key**
Decreases the value to set
- 4 **Reset (burner reset)**
If the oven does not turn on after three attempts, the flame control blocks. Pressing the RESET button restores the functionality and the oven tries to turn on again
- 5 **Led**
 - fixed led: an end-of-cooking buzzer is being set up
 - flashing led: end-of-cooking buzzer started (countdown in progress)
 - led off: end-of-cooking buzzer inactive
- 6 **Light key**
Turns the light on and off
- 7 **ON/OFF key**
Turns the control panel on and off activating/deactivating the burner
- 8 **Timer key**
Activates an end-of-cooking signal (buzzer)

Fig. 3

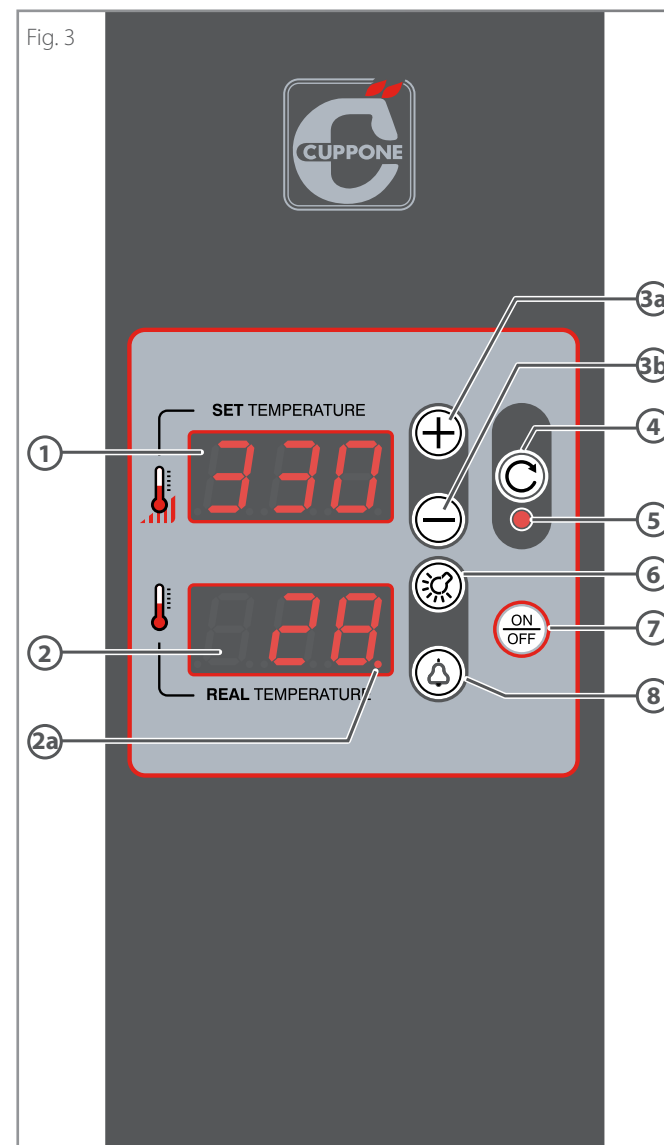

 The control panel must be used only with dry and clean fingers.

Continuous and prolonged pressing of the "+" and "-" keys increases or decreases the value quicker.



Use guided procedure

A - Turning the oven on

Check that the gas stop-cock is open.

► Fig. 4

Press the **ON/OFF** key.



The oven starts to warm up with the last temperature set before switch-off.

The oven does not turn on

A safety system checks that the oven has ignited correctly: otherwise, three more ignition attempts are made automatically, at the end of which, if the oven does not ignite yet, the message **"Err brU"** appears on the displays and the burner goes into lockdown.

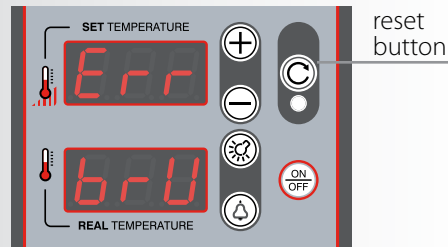

How to solve the problem:

- check that the system's gas stop-cock is open;
- press the **reset (burner reset)** button: the oven tries to turn on again;
- disconnect the power plug from the socket and reconnect it by turning it upside down (inversion between phase and neutral).

If after carrying out these operations the problem is not solved, contact technical service.

B - Setting the preheating

Preheating must have the temperature shown in the table on page 8. It must be carried out without products in the cooking chamber and takes about an hour for the oven to be ready for cooking.

► Fig. 5

With the oven on, to set the temperature, press the + key or the - key: the display will begin to flash.

Use the + and - keys to reach the desired temperature and wait for three flashes of the display to indicate that the setting has been saved. The oven starts to heat up to reach the set temperature.

During normal operation, **the upper display shows the temperature set** in the cooking chamber while the **lower display shows the temperature detected by the temperature probe** (real temperature).

C - Starting cooking

► Fig. 6

Once preheating is complete, you can start cooking and bake the products using personal protection equipment (e.g. gloves) and tools suitable for contact with food and made of material resistant to high temperatures (e.g. steel).



For optimal results, always adhere to the oven capacity declared by the Manufacturer and position the products to be cooked evenly in the cooking chamber.

During cooking, it is always possible to change the temperature acting as usual.

D - Switching the light on (optional)

► Fig. 7

When necessary, it is possible to switch on the oven light to check the cooking, acting on the light key. Press the same key to switch it off.

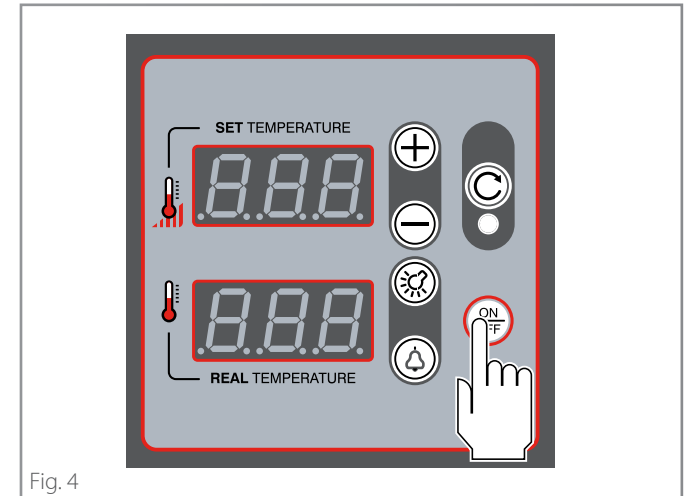

Fig. 4

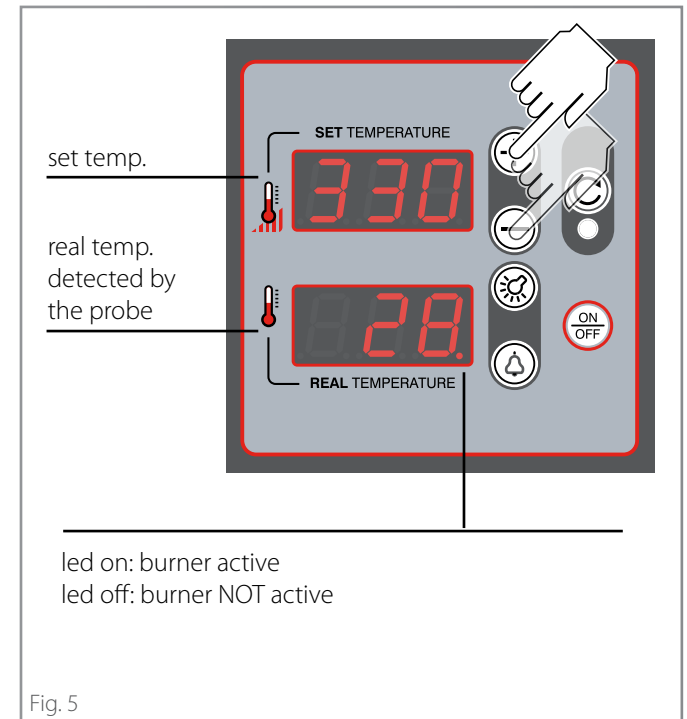
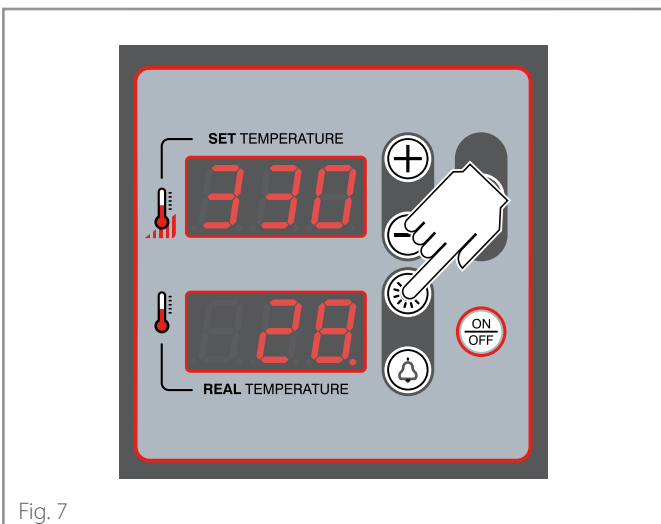
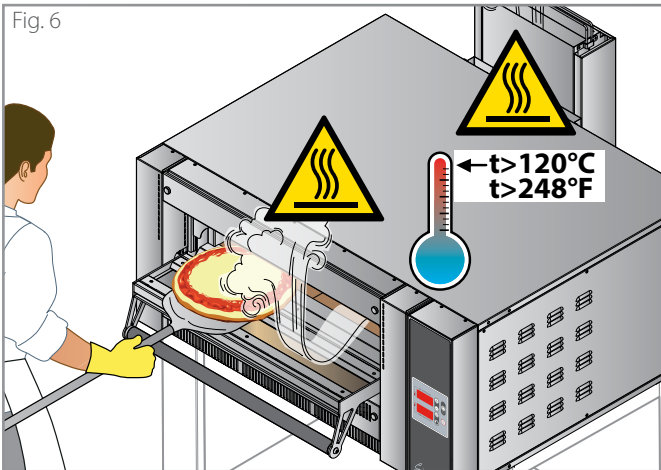

Fig. 5



E - Activating an end-of-cooking signal (buzzer)

► Fig. 8

If you wish, you can enable a buzzer that will go off when the set time expires, warning that cooking is complete.

- (A)** To activate it, **with the oven on**, press the "timer" key.
- (B)** The upper display starts flashing and the led under the "reset" key turns on steadily; using the "+" or "-" keys it is possible to set **the time after which the buzzer should sound**.
- (C)** The upper display shows digits separated by a dot, indicating the minutes on the left and multiples of 10 seconds on the right (for example, 3.5 indicates 3 minutes and 50 seconds, the number 3 alone indicates 30 seconds).
- (D)** After setting, the countdown starts, during which the led under the "reset" button flashes. At the end of the set time a buzzer will sound to indicate the end of cooking.

(Warning!) **the oven continues heating** when the buzzer goes off!

If you want to check how much time is left until the buzzer sounds, press the "timer" button: the remaining time will be shown on the upper display (e.g. 3 = 30 seconds)

To cancel the buzzer function, press the "timer" button and set the time to "0".

F - Switching the oven off

► Fig. 9

To switch the oven off, keep the ON/OFF key pressed for about 2 seconds.

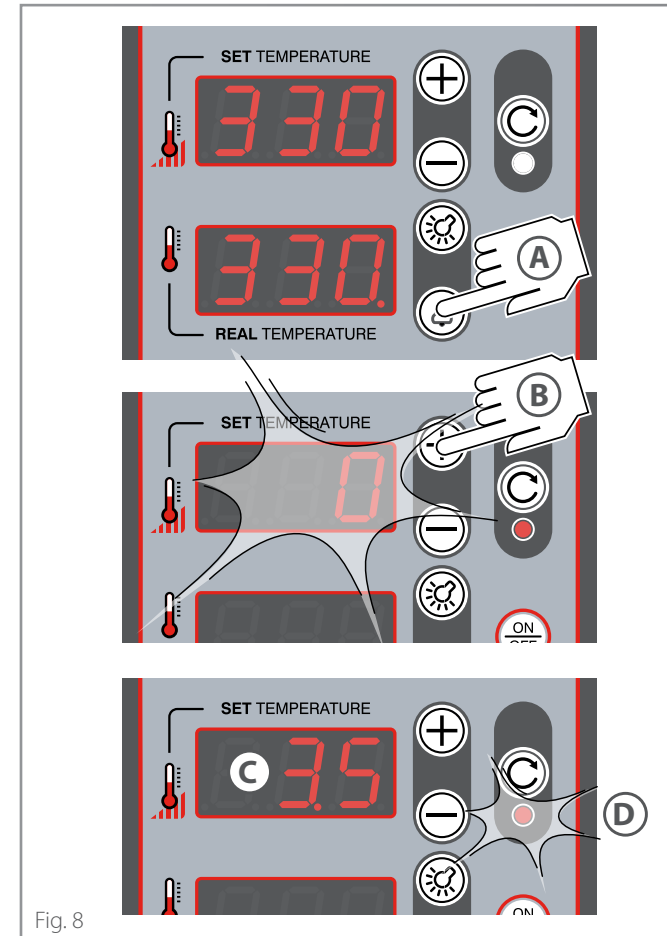

Fig. 8

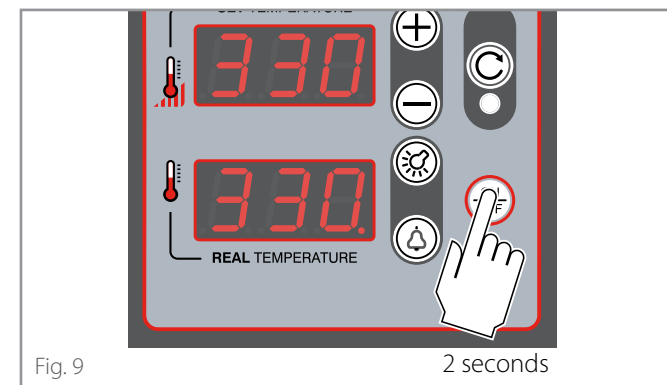





Fig. 9

2 seconds

Warnings

 Before any cleaning, it is necessary to **switch off the power** to the appliance (acting on the system switch), close the gas stop-cock and wear suitable personal protection equipment (e.g. gloves, etc.). The user must carry out only routine maintenance, for extraordinary maintenance, contact a Service Centre requesting service from an authorised technician. The Manufacturer warranty does not cover damages due to negligent or incorrect maintenance or cleaning (e.g. use of unsuitable detergents).

 **Any cleaning must be carried out with the oven completely cold and wearing adequate personal protection devices (e.g. gloves, etc.).**

 When cleaning any part or accessory do NOT use:

- abrasive or powder detergents;
- aggressive or corrosive detergents (e.g. hydrochloric or sulphuric acid, caustic soda, etc.). Caution! Never use these substances also when cleaning the substructure/floor under the appliance or its base;
- abrasive or sharp tools (e.g. abrasive sponges, scrapers, steel brushes, etc.);
- steamed or pressurised water jets.

 It is best to have a service centre perform maintenance and inspection on the appliance at least once a year to ensure top working and safety conditions.

► **Fig. 10** Keep the vents of the electrical compartment clean and clear.

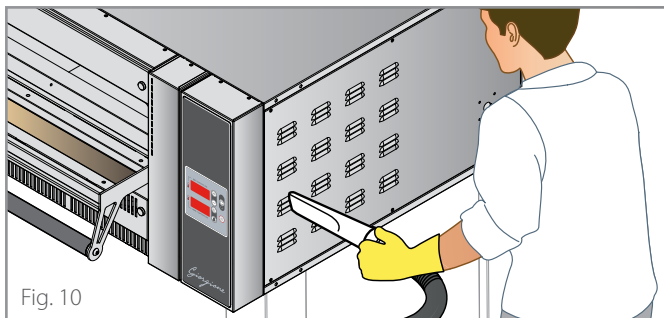

Fig. 10

Oven cleaning

Cleaning the external steel parts

Use a cloth dampened with hot soapy water and end with rinsing and drying.

Cleaning the glass

Clean any glass with a soft cloth and special glass detergent.

Cleaning the display

Clean the display with a soft cloth and a little detergent for delicate surfaces. Avoid using considerable quantities of product since any infiltration may damage the display. Avoid also using very aggressive detergents that may damage the material the display is made of (polycarbonate).

Cleaning the refractory surface

► **Fig. 11**

 *On the refractory surface, there are normally some food residues (e.g. fat, food residues, etc.) that must be removed frequently for health and safety reasons.*

Remove the coarser food residues with a natural fibre brush; then, if necessary, remove the refractory bricks of the cooking surface as shown in the figure and suck the carbonized residues accumulated under them on the bottom of the oven with an ash extraction bin.

Never use liquids to clean the refractory surface.

 While reinserting the bricks, be careful not to pinch your fingers.

 *Replacement refractory bricks can be obtained from the Manufacturer on request.*

If manual cleaning is not enough, use the PYROLYSIS function

► see page **13**

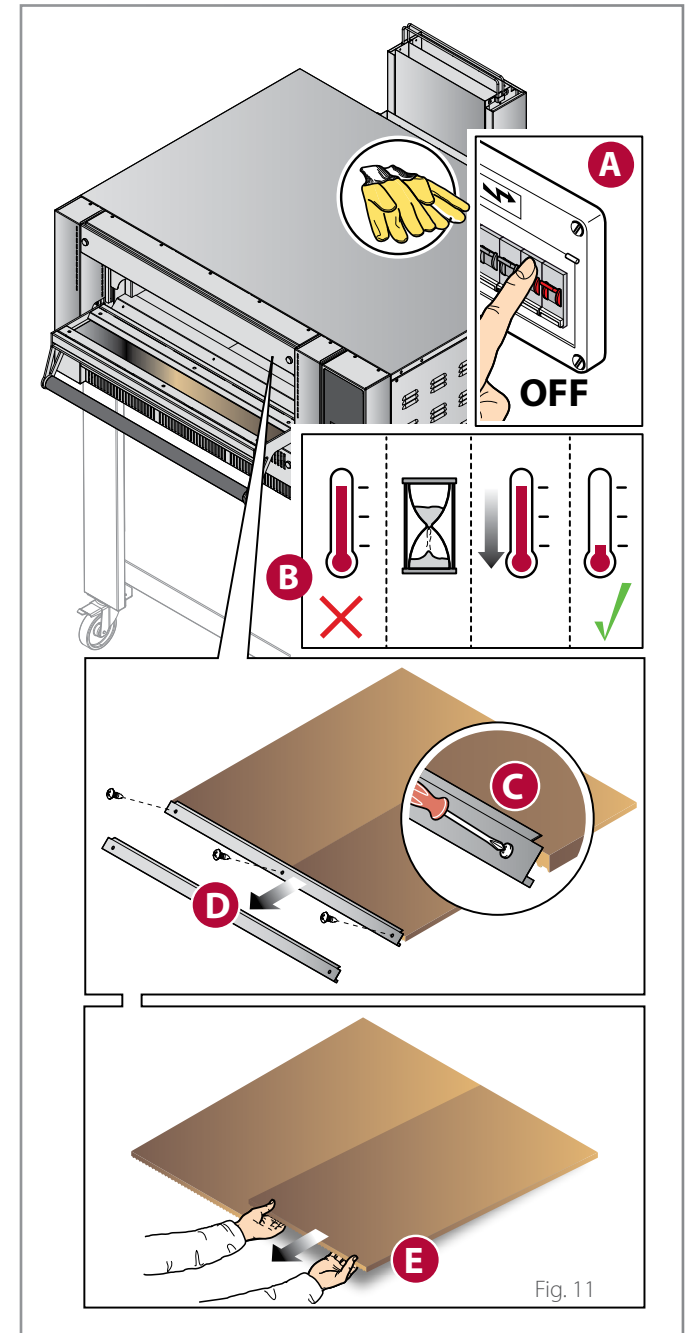

Fig. 11

Maintenance and cleaning

Cleaning the chamber with the pyrolysis function

Pyrolysis is a thermochemical crystallization process of food residues that have deposited in the cooking chamber, which takes place by bringing the oven up to 400°C - 725°F.

 Before starting the pyrolysis, remove the coarser food residues with a natural fibre brush.

A ► **Fig. 12** Set the **chamber temperature to 400°C-725°F** using the “+” or “-” keys, until the desired value is displayed (e.g. 400°C - 725°F),

B switch the lights in the cooking chamber off;

C when the temperature is reached, switch the oven off with the ON/OFF key and let it cool down with the door closed;

E ► **Fig. 13** With a cold oven, clean the chamber from the crystallized food residues using a natural fibre brush and then vacuum with an ash extraction bin

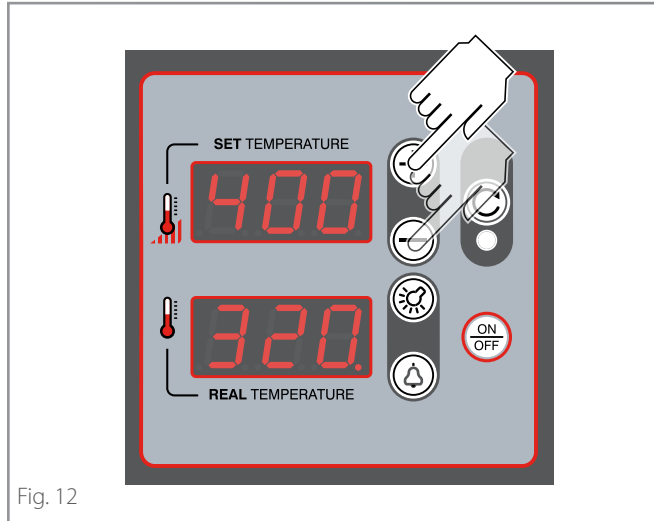

Fig. 12

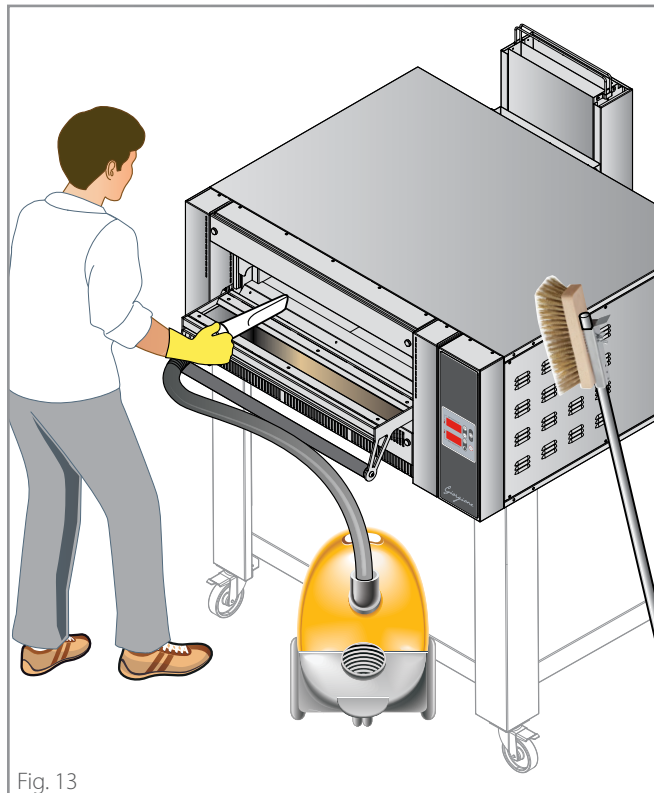





Fig. 13

Replacing components

 The user must replace **only** the stated components: in case of a fault or for extraordinary maintenance, contact the retailer, requesting service from an authorised technician. As replacements, always use original spare parts to be requested from the Manufacturer: using non original parts might cause injuries to people, non optimal performance and even serious damage of the appliance itself.

 Before any replacement, it is necessary to **switch off the power** to the appliance (acting on the system switch) and wear suitable personal protection equipment (e.g. gloves, etc.).

 **Any replacement must be carried out with the oven completely cold and wearing adequate personal protection devices (e.g. gloves, etc.).**

Replacing the door glass

► **Fig. 14**

Door external heat-protection glass replacement

► **Fig. 15**

Fig. 14

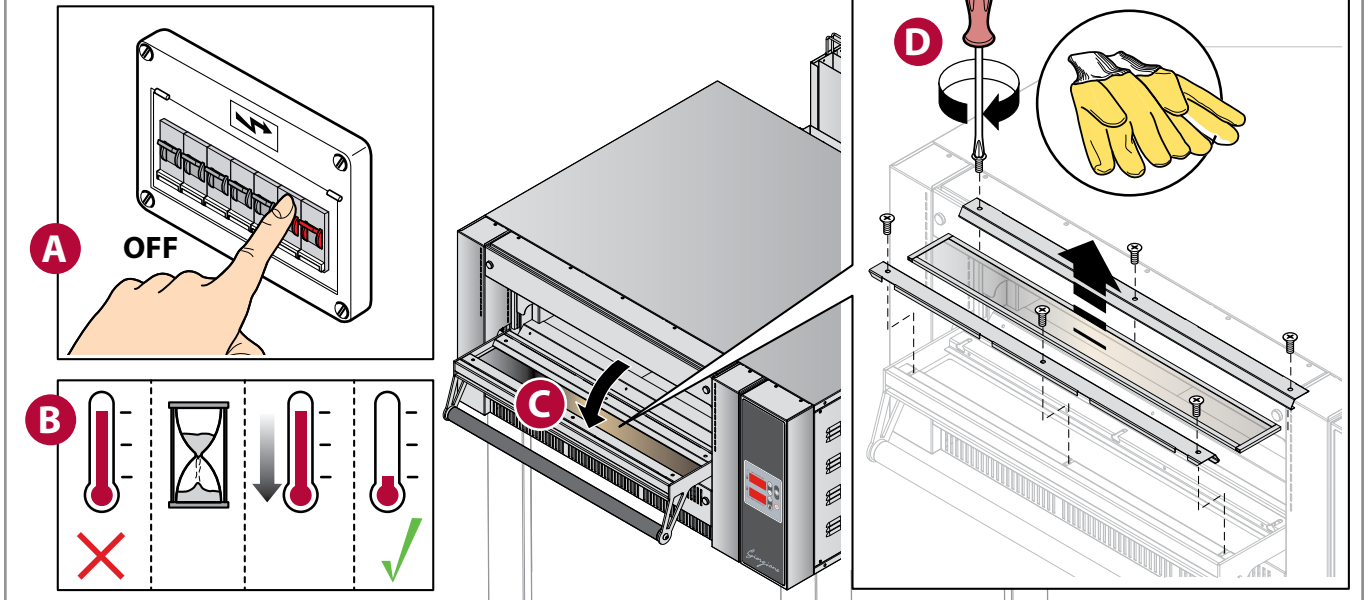
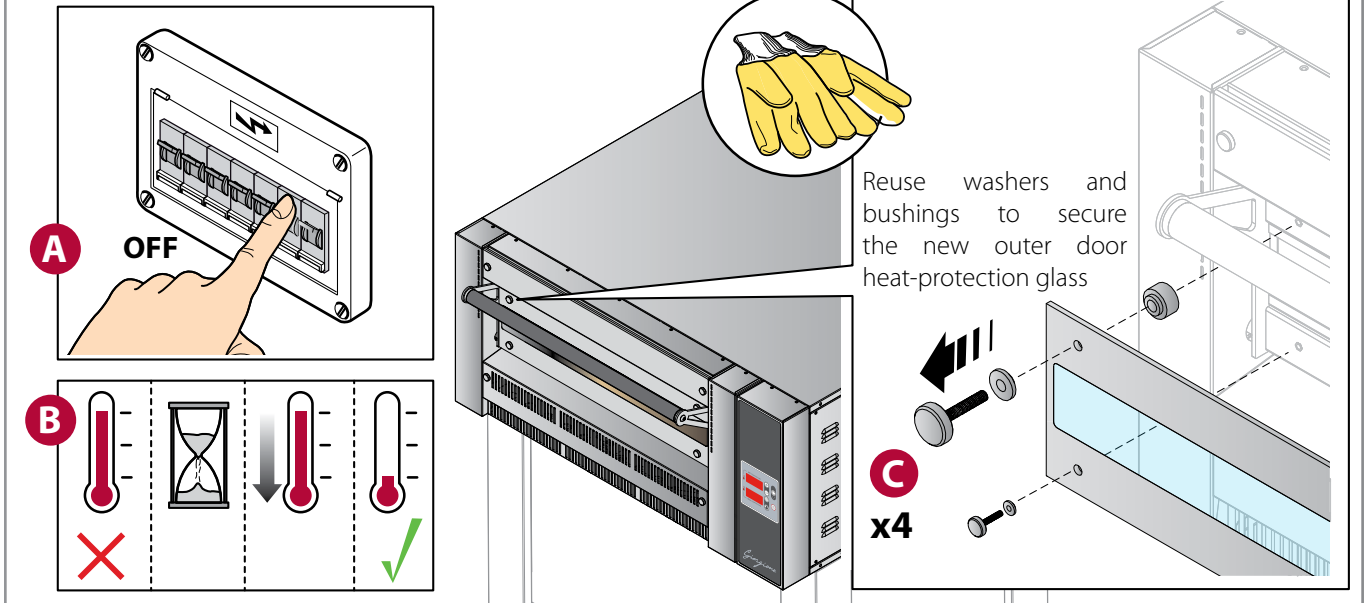

Fig. 15



Replacing the internal bulb and glass

► Fig. 16

Before replacing the bulb, **switch off the power** to the appliance (acting on the system switch); it is not enough to use the ON/OFF key, because bulbs can still be live.

Never touch the bulb glass with your bare hands; always wear gloves.

Never switch the oven on without having refitted the bulb protective glass; replace it straight away if it breaks.

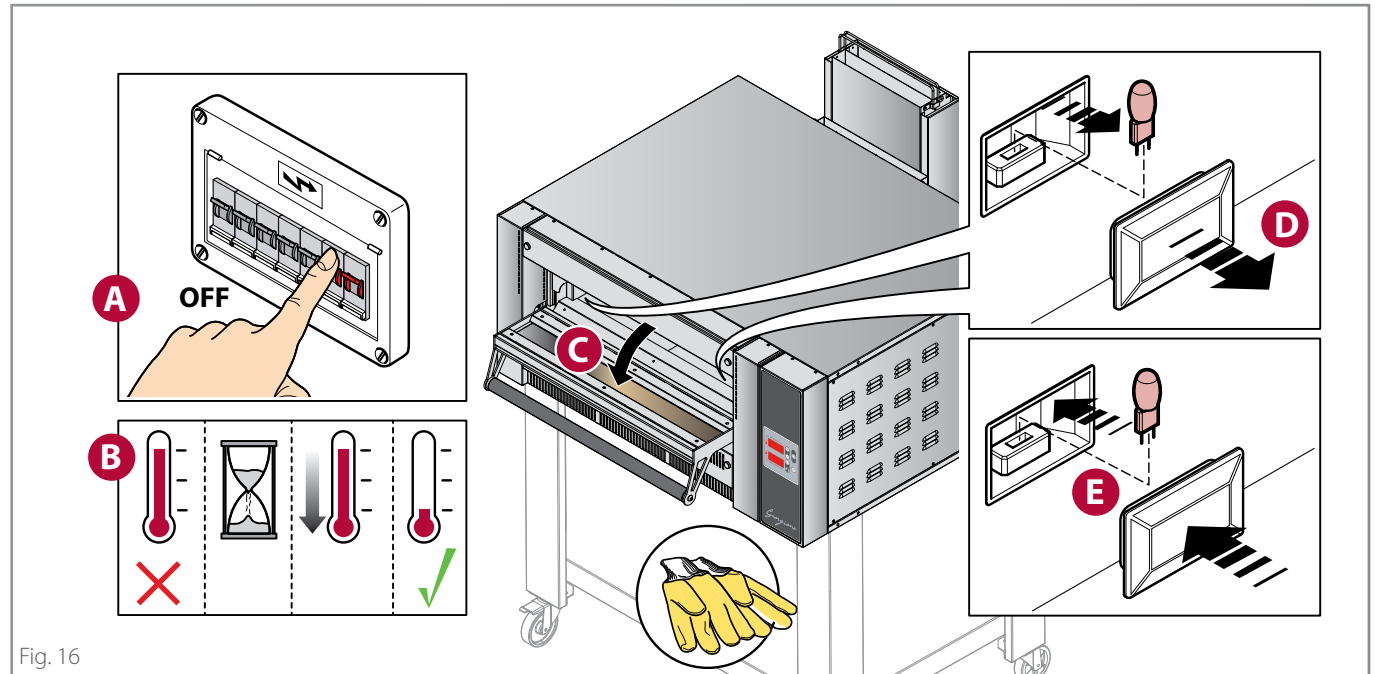

Replacing the refractory bricks

► Fig. 17

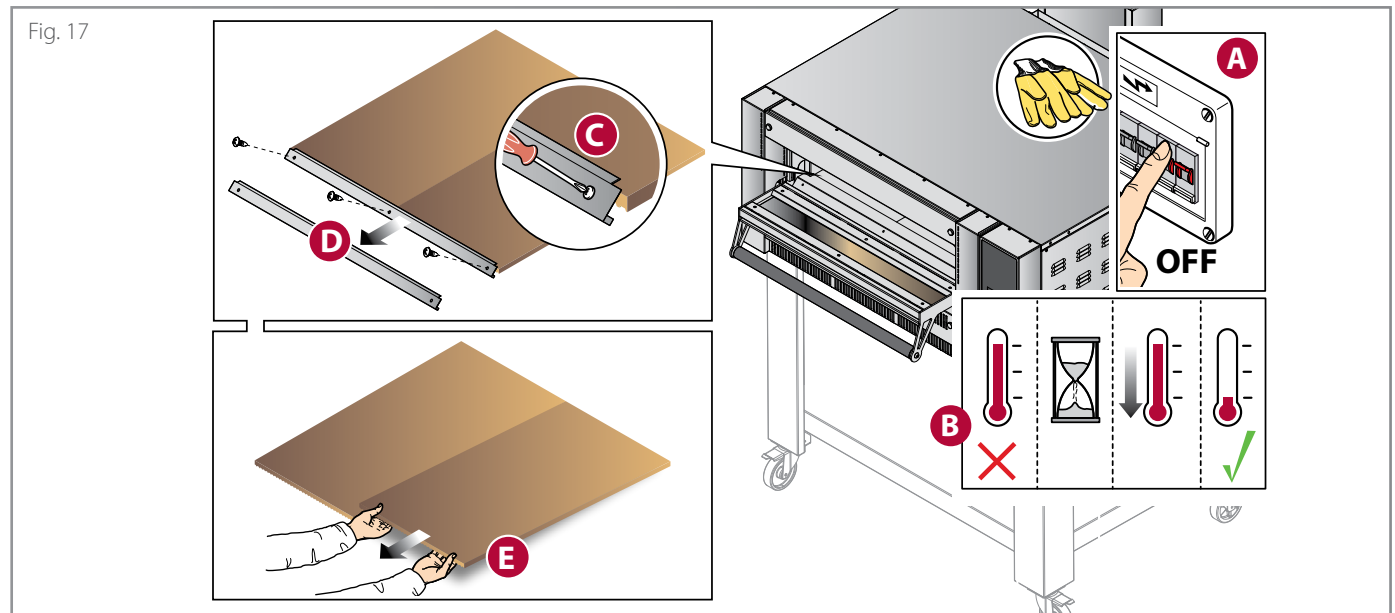

Oven downtime for prolonged periods

► **Fig. 18** During any inactivity periods, disconnect the power supply and turn off the gas stop-cock. Protect the steel outside surfaces passing over them with a soft cloth slightly damp with Vaseline oil.

Leave the door ajar to guarantee correct ventilation.

Before resuming operations:

- accurately clean the equipment and accessories;
- reconnect the appliance to the power supply and open the gas stop-cock;
- inspect the equipment before using it.

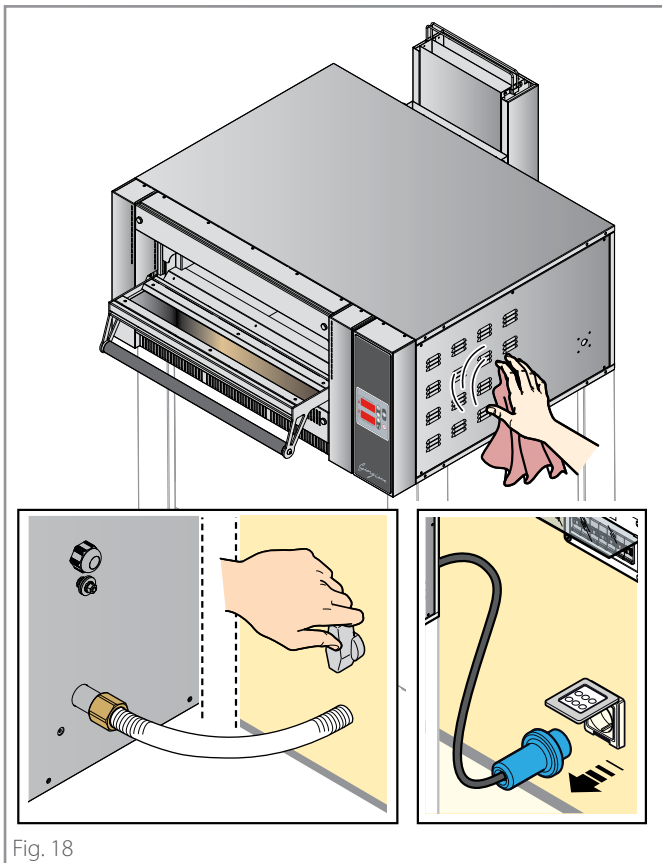



Fig. 18

Disposal at end of life

 To avoid any unauthorised use and associated risks, before discarding the machine make sure it cannot be used; for this purpose, cut and remove the power cord (once the equipment is unplugged).

Make sure no child can accidentally remain trapped inside the cooking chamber, locking the door (for example, with adhesive tape or locks).

Equipment disposal

 Pursuant to art. 13 of Legislative Decree no. 49 of 2014 "Implementation of WEEE directive 2012/19/EU on electric and electronic waste", the barred bin symbol specifies that the product was introduced on the market after August 13, 2005 and that it must not be discarded with other waste at the end of its working life but disposed of separately. All the equipment has been made with recyclable metal materials (stainless steel, iron, aluminium, zinc plate, copper, etc.) that as a percentage make up more than 90% of the weight. Attention must be paid to the management of this product at the end of its life, reducing any negative impact on the environment and improving the efficiency of resources, applying the principles of "who pollutes pays", prevention, preparation for re-use, recycling and recovery. Please remember that illicit or incorrect product disposal is punishable by law.

Information on disposal in Italy

WEEE equipment in Italy must be delivered to:

- to Collection Centres (also named eco-islands or eco-platforms)
- the dealer where new equipment is purchased who must withdraw it free of charge ("one to one" withdrawal).

Information on disposal in European Union countries

The EU Directives on WEEE equipment has been adopted in different ways by different countries, therefore in order to dispose of this equipment correctly we suggest that you contact your local authority or your dealer in order to ask the correct method of disposal.

Disposing of ashes and food residues

 The ash and food residues removed with cleaning must be disposed of according to the regulations in force in the country where the oven is used.

If in doubt, we suggest contacting the local authorities to ask for the correct method of disposal.

While waiting for disposal, the ash and food residues must be stored in fireproof metal cans, resistant to high temperatures and provided with a lid that must always remain closed.

Keep the latter away from the elements and in a place inaccessible to children and animals.

Do not approach materials that can be flammable, explosive or heat-sensitive.

Warranty conditions

- 8.1 Each product sold is to be considered compliant when delivered in the quantity, quality and type indicated in the written Confirmation, please refer to the provisions of art. 1.2.
- 8.2 The Seller guarantees:
 - (a) that the Products are free from defects in materials or workmanship, and
 - (b) that (excluding the case of known defects or which should have been known by the Buyer) the Products are of marketable quality.
- 8.3 Any hidden defects in the Products must be reported in writing by the Buyer within 8 days of discovery, under penalty of forfeiture. Packaging defects - even if they have caused defects or damage to the internal product - which had to be reported at the time of delivery, are excluded pursuant to art. 5.8.
- The defect report must contain the specific indication of the defective Products, a detailed description of the type of defect that the Product has, as well as the delivery date and that of discovery.
- The warranty is excluded if the defect derives from the Purchaser's actions such as, by way of example, incorrect installation of the Product, use of the Product in a manner that does not comply with the normal method of use, failure to comply with the instructions contained in the use and installation manual, tampering with the Product. The warranty does not cover normal wear and tear of the Product due to use.
- The Seller is responsible for defects that occur within one year from the activation of the warranty as provided for in point 8.12.
- 8.4 the Seller will have the right to examine, or have a representative examine, the Product and, if this shows the existence of the defect, the Buyer will be entitled to a repair or replacement, at the Seller's sole discretion.
- It is understood that, once the defect has been reported, the Buyer must not use the Product until it is viewed by the Seller or its representative. In the event that the Seller realizes that the Product has been used after the complaint, the Buyer loses the right to obtain a replacement or repair.

- 8.5 Replacement or repair will take place under the following terms:
 - a) The Seller may repair the defective Products by going - or sending a representative - to the place where such Products are located;
 - b) Alternatively, the Seller may repair the defective Product at its own factory, or other place chosen by the Seller,
 - c) Alternatively, the Seller may opt for the replacement of the defective Products;
- In the event that the repair / replacement is not possible, the Seller will pay the Buyer a refund to be quantified, a refund which, however, must not exceed the price paid. Compensation for damage is excluded.
- 8.6. In case of repair of the Product at a place chosen by the Seller or in case of replacement of the defective Product, the shipment of the Product will be borne by the Buyer who must send it, at its own expense and risk, to the place stated by the Seller.
- 8.7 In no case will the Seller be liable for indirect or consequential damages and/or for loss of profits that the Buyer may suffer as a result of defects in the products such as (but not limited to) cancellation of orders by customers, penalties for delayed deliveries, penalties or refunds of any kind.
- 8.8 The Seller shall indemnify the Buyer from any liability or damage arising from defective Products, unless such liability derives from the Buyer's negligent acts or omissions or from the latter's non-fulfilment of its obligations.
- 8.9 The Seller is not liable for damage to persons and/or property that may derive from the improper use of the Products and/or from any use, processing or transformation of the Products that do not comply with their intended use and/or the instructions provided by the Seller. Save the hypothesis of gross negligence or wilful misconduct by the Seller.
- The Seller will also not be liable in the event of damage to property or injury to people or in the case of malfunction or damage or deterioration of the Product deriving from the fact that the Product has been connected to a non-compliant electrical system.
- 8.10 The Buyer will not be able to raise any claim for injury to people or damage to property other than those which are the subject of the contract, or for loss of profit, unless it

results from the circumstances of the case that the Seller has committed "gross negligence".

- 8.11 "Gross negligence" does not include any and all lack of adequate care and expertise, but means an act or omission by the Seller which implies either a failure to take into consideration those serious consequences that a conscientious supplier would normally have foreseen as probably occurring, or a deliberate neglect of any consequence deriving from such act or omission.
- 8.12 The effect of the warranty referred to in this article is subject to its activation to be carried out through the website www.cuppone.com within 48 hours after the time the Product is installed.

Spare parts

- 9.1 For 10 years from delivery of the Product, the Seller undertakes, at the request of the Buyer, to assist him in identifying spare parts for product maintenance. In any case, the Seller is in no way responsible for the failure to identify such sources.

Applicable law and multi-step clause

- 11.1 Italian law, as the Seller's law, will govern sales made on the basis of these General Conditions.
- 11.2 The Parties exclude the application of the Vienna Convention.
- 11.3 The parties will submit any disputes arising from sales made on the basis of these General Conditions to the conciliation attempt provided for by the Conciliation Service of the Milan Arbitration Chamber. In the event that the attempt fails, any disputes, even of a non-contractual nature, deriving from sales made on the basis of these General Conditions, will be resolved by arbitration according to the Rules of the Milan Arbitration Chamber, by a single arbitrator/three arbitrators, appointed in compliance with this Regulation. The Arbitration Tribunal will judge according to Italian law. The seat of the arbitration will be in Milan (Italy). The language of the arbitration will be Italian.

Something is not working...

What to do in case of any malfunction

- Try and check the following tables. If none of the proposed solutions solves the problem, continue reading the following procedure.

- Check if any error messages are displayed.

- Note the oven data (rating plate) and the date and number of the appliance purchase invoice.

Serial number.....

Model.....

Invoice date.....

Invoice number

- Read the chapter on warranty carefully.



Warranty - page 17.

- Contact the Dealer with the details of the oven. While waiting for Technical service, disconnect the appliance from the power supply and close the gas stop-cock.

CUPPONE 1963

Cuppone F.lli S.r.l.

Via Sile, 36

31057 Silea (TV) - ITALY

T +39 0422 361143

F +39 0422 360993

info@cuppone.com - www.cuppone.com

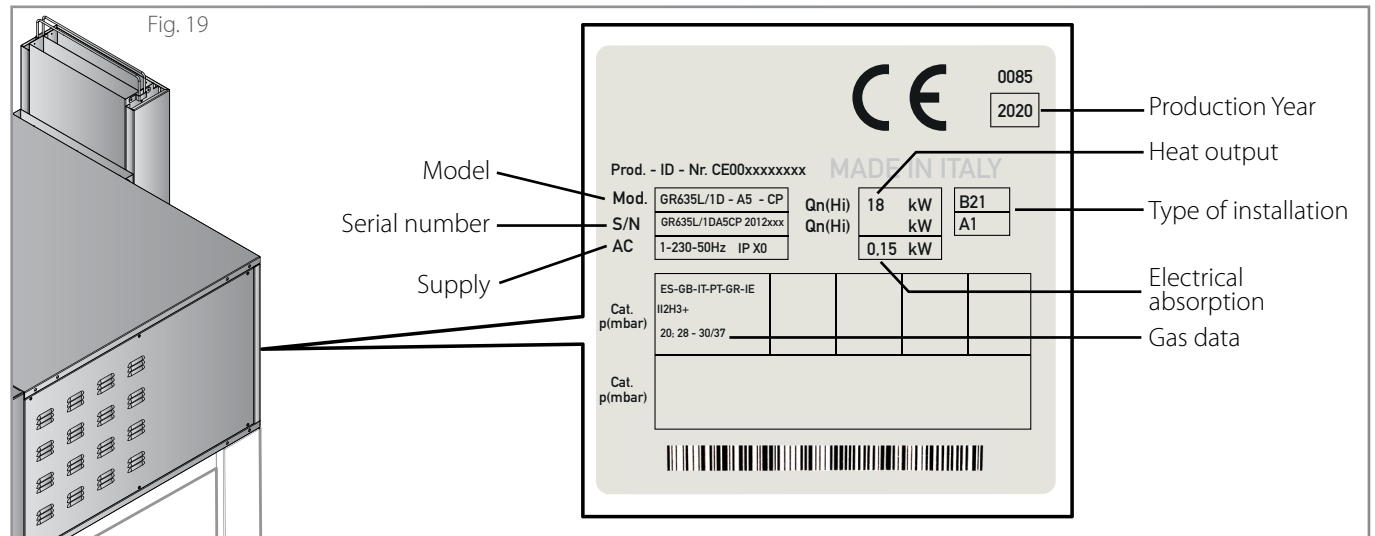

Problem	Solution
The oven does not turn on	<ul style="list-style-type: none"> • Make sure the oven is correctly connected to the mains (plug correctly inserted into the socket) and that the mains are working. • Make sure the main switch is ON.
The oven does not cook evenly	<ul style="list-style-type: none"> • Make sure you set the cooking temperature correctly. • In case of incomplete baking cycles, change the positions of the pizzas.
The first pizzas are burnt	<ul style="list-style-type: none"> • During preheating, the temperature has been set too high: the refractory surfaces (without pizzas) have become too hot and burnt the first pizzas.

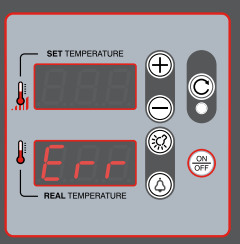
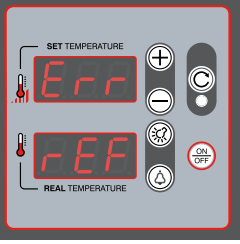
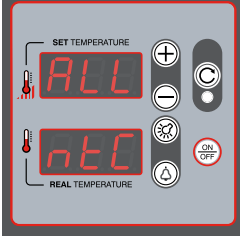
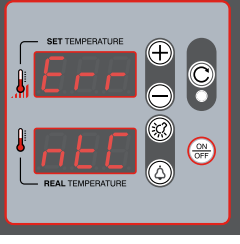
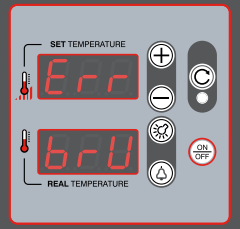
DISPLAYED MESSAGE	PROBABLE CAUSES	SOLUTIONS FOR THE USER
	-	Contact the Dealer
	-	Contact the Dealer
	-	Contact the Dealer
	-	Contact the Dealer
	<p>A safety system checks that the oven has ignited correctly: otherwise, three more ignition attempts are made automatically, at the end of which, if the oven does not ignite yet, the message “Err brU” appears on the displays and the burner goes into lockdown.</p>	<ul style="list-style-type: none"> • check that the system's gas stop-cock is open; • press the reset (burner reset) button: the oven tries to turn on again; • disconnect the power plug from the socket and reconnect it by turning it upside down (inversion between phase and neutral). <p>If after carrying out these operations the problem is not solved, contact the Dealer</p>



CUPPONE 1963

Cuppone F.lli S.r.l.

Via Sile, 36

31057 Silea (TV) - ITALY

T +39 0422 361143

F +39 0422 360993

info@cuppone.com - www.cuppone.com

