

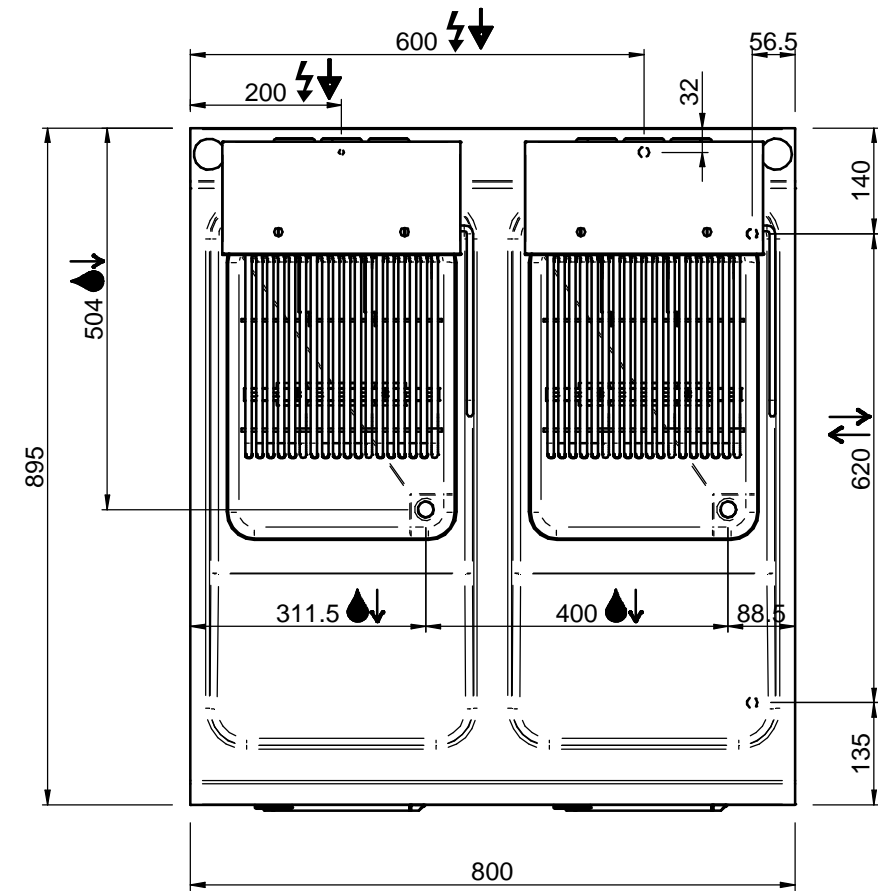

MOD : E9/F36A8-N

Production code : DIFRBE98A

09/2023

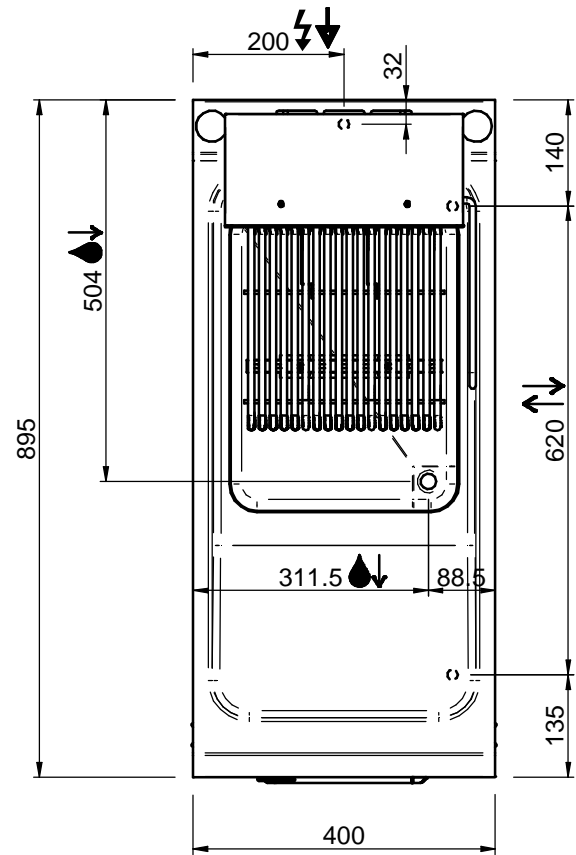
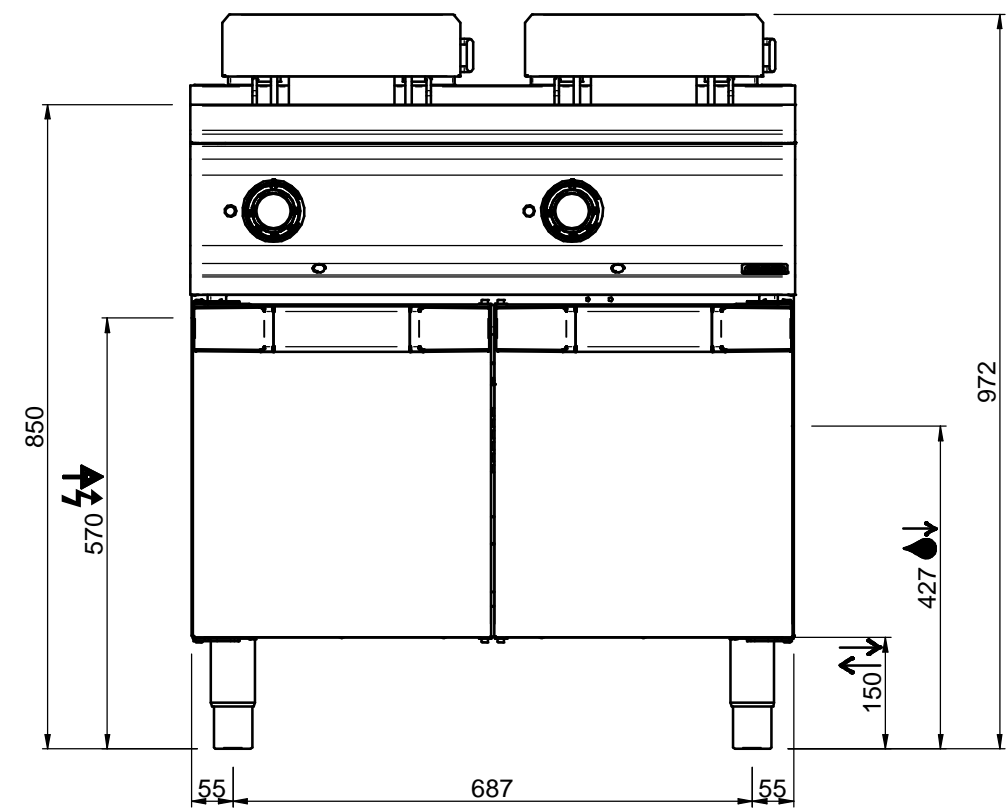
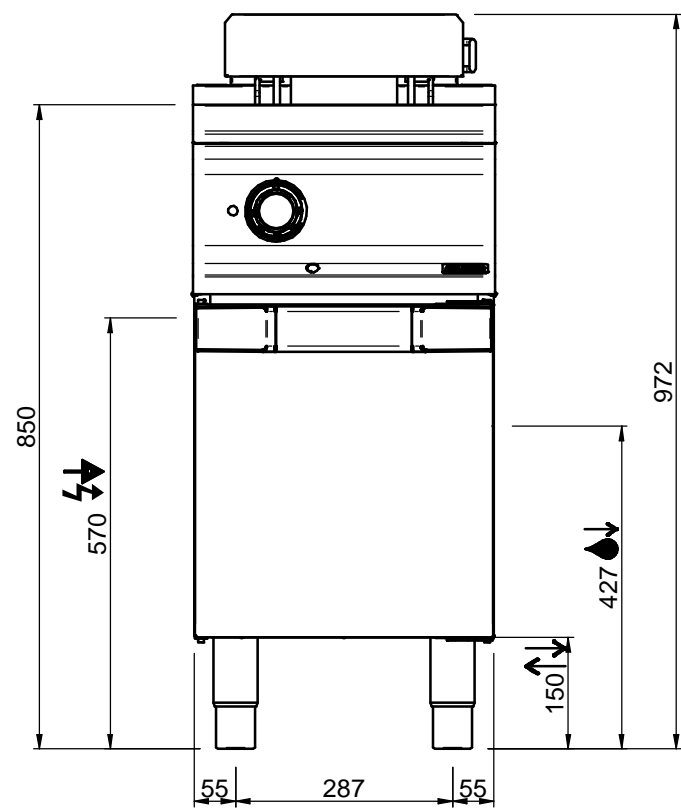

LEGENDA SIMBOLI / LEGEND



INGRESSO GAS / GAS INLET
(EN 10226-1) Ø M 1/2"



INGRESSO ACQUA /
WATER INLET Ø M 1/2"



ATTACCO EQUIPOTENZIALE /
EQUIPOTENTIAL



ALIMENTAZIONE ELETTRICA /
POWER SUPPLY



SCARICO ACQUA / OLII
WATER / OILS DRAIN



REGOLAZIONE PIEDINI /
FEET ADJUSTMENT (h 0/+50)
/ TOP VERSION (h 0/+5)