

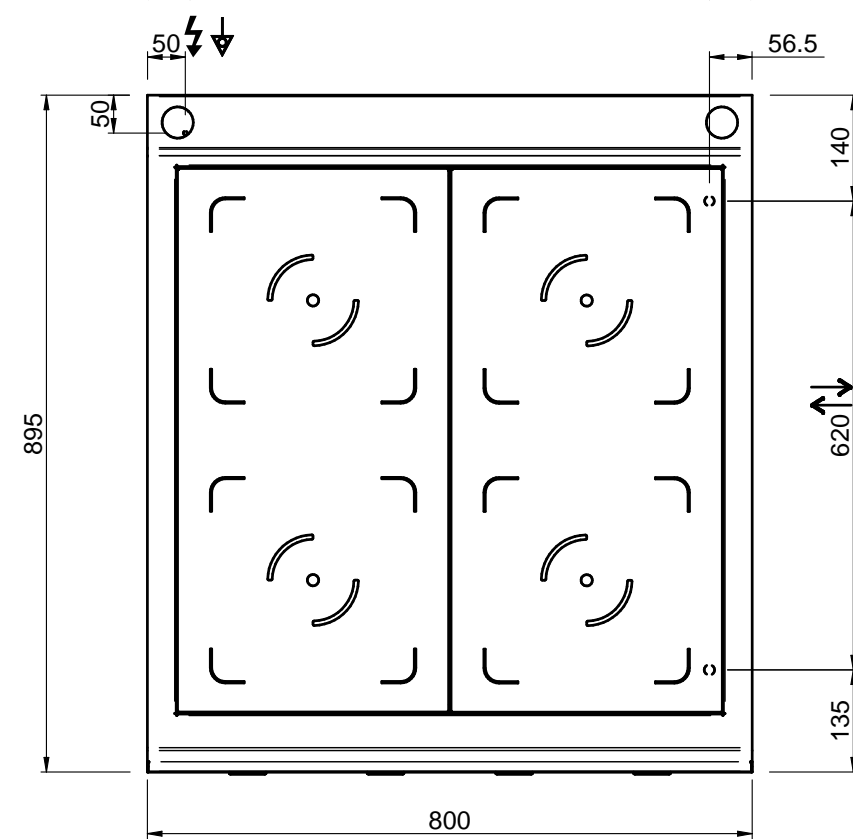

**MOD : E9/4IDA8-N**

**Production code : DIIN98A**

**09/2023**

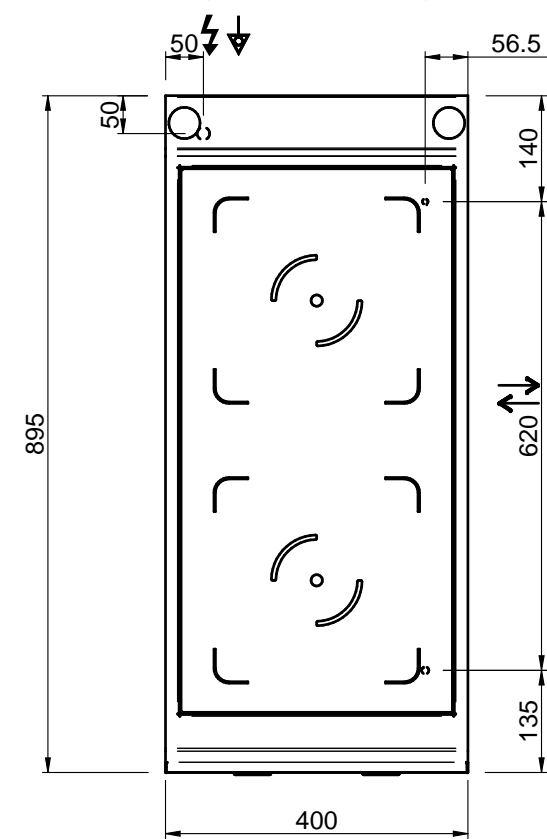
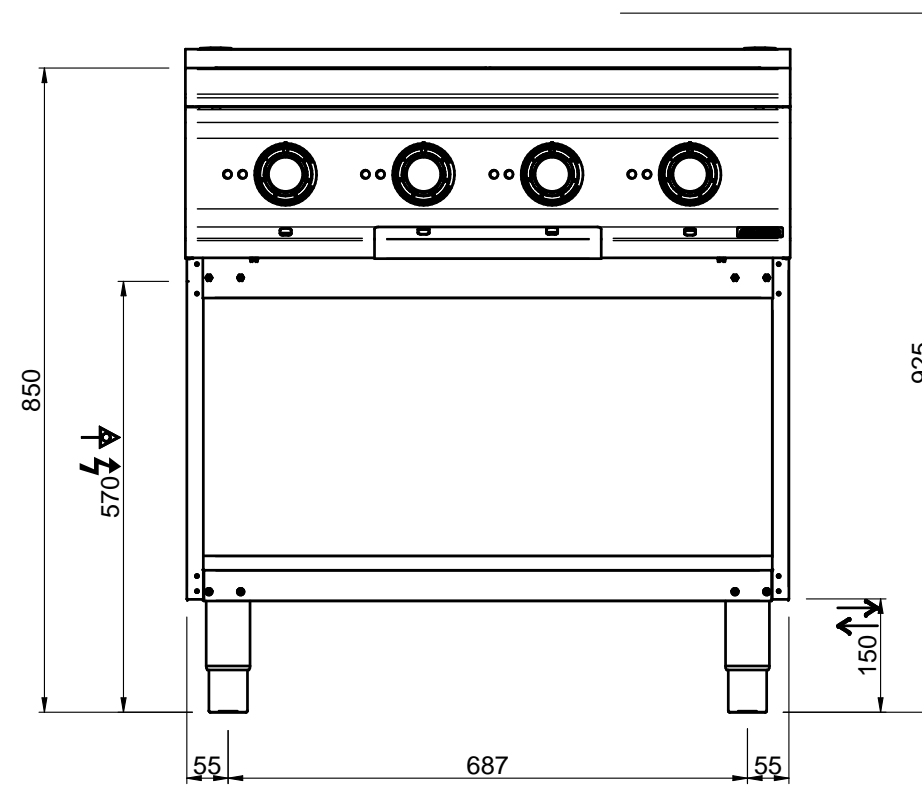
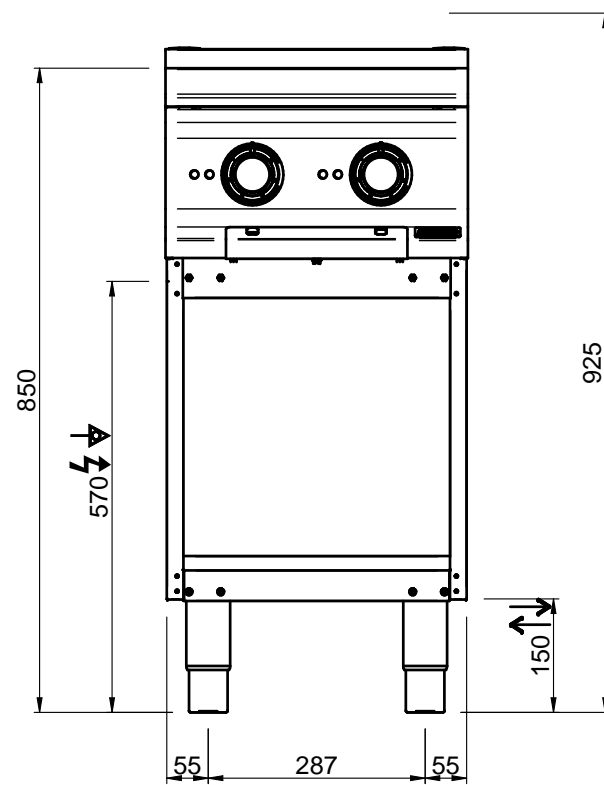

LEGENDA SIMBOLI / LEGEND



INGRESSO GAS / GAS INLET  
(EN 10226-1) Ø M 1/2"



INGRESSO ACQUA /  
WATER INLET Ø M 1/2"



ATTACCO EQUIPOTENZIALE /  
EQUIPOTENTIAL



ALIMENTAZIONE ELETTRICA /  
POWER SUPPLY



SCARICO ACQUA / OLII  
WATER / OILS DRAIN



REGOLAZIONE PIEDINI /  
FEET ADJUSTMENT (h 0/+50)  
/ TOP VERSION (h 0/+5)