











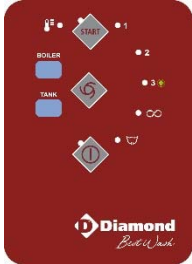



10/2020

Mod: DXE8/6

Production code: IT3813BEDD

	Model	DXE8/6	
	Code Production	IT3813BEDD	
	Interface		
			
	Overall Dimension (Width-Depth-Height) *open	mm	724x818x1529(2010*)
	Packaging Dimension (WxDxH)	mm	760x840x1520
	Gross weight	Kg	95
	Net weight	Kg	85
	Volume	mc	0,98
	Rack size	mm	500x500
	Max door /hood opening	mm	450
	Max glasses/plate Height	mm	440/450
	General construction		single skin
	Door/hood Construction		single skin
	Tank construction		deep drawn
	Tank volume	liter	15
	Tank heating element	W	2.100
	Tank surface strainers		yes-composite
	Wash pump type		double flow
	Wash pump power	W	500
	Wash temperature	°C	55
	Boiler type		without pressure
	Boiler volume	liter	6
	Back-flow system		break tank
	Boiler heating element	W	6.000
	Rinse booster pump		YES
	Rinse booster pump power	W	200
	Rinse temperature	°C	80
	Rinse water consumption	Liter /rack	2,6
	Optimal external water pressure	bar	1-4
	Drain system		deep drain
	Drain pump		standard built in
	Rinse aid dispenser		YES
	Detergent dispenser		YES
	Wash cycle	sec	120 - 180 - continuous
	 Sanitation washing cycle		YES
	Electric Power	W	6.500
	Electric Connection	V - ph - Hz	400V 3N 50Hz
	Fuse	A	16
	Water softner		NO
	Plates racks		YES
	Flat Rack		YES
	Cutterly Rack		YES
	Electric cable		YES
	Drain hose		YES
	Fill hose		YES

A		∅ 35 mm M	A		∅ 25 mm M
B		G 3/4" M	B		EXIT
C		Power supply			G 3/4" F

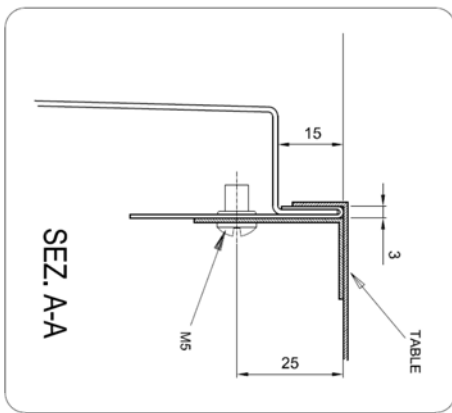
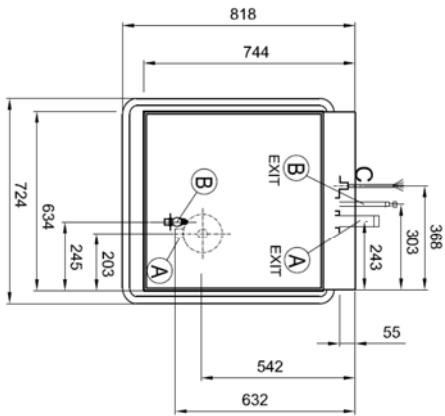

* LUCE UTILE PER CESTELLO
USEFUL SPACE FOR BASKET
LUMIERE UTILE POUR PANIER
NITZBARE OFFENING FÜR KORBE
ABERTURA UTIL PARA CESTO

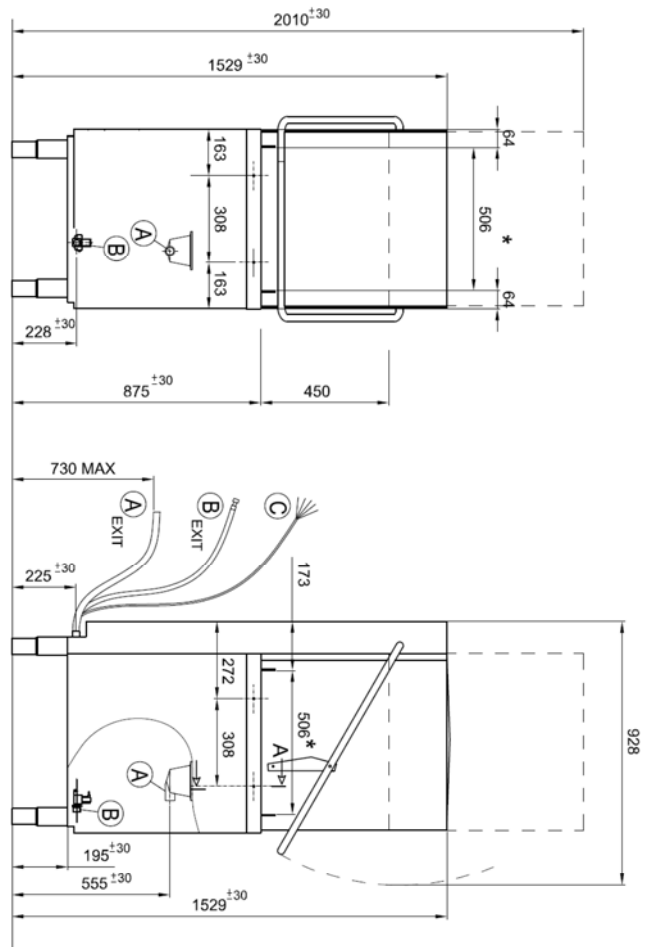

Installation layout

Hood type with drain pump

NH50PS 00

