

07/2018

Mod: **CSL1507-VTB**

Production code: **HPL/1504-P**



**Diamond**  
catering equipment

# Connection diagram

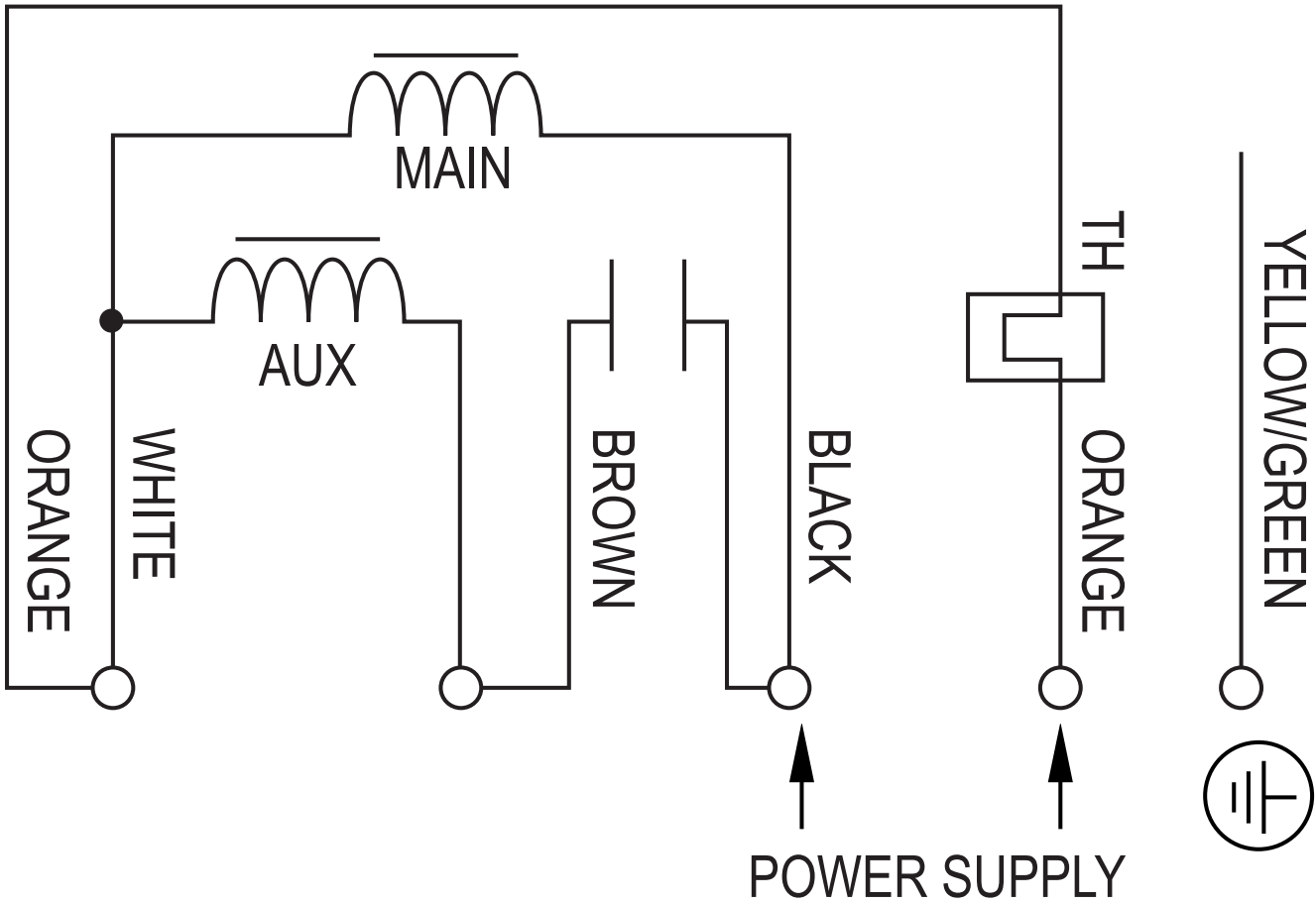

BLACK
BLUE
RED
YELLOW
BROWN
GREEN
WHITE
YELLOW/GREEN
ORANGE
GREY
VIOLET
SPEED 1,2,3,4
PHASE
NEUTRAL